

# ACANTHUS

cast stone products

## POOL SURROUND - PS10CP SMALL FULL CIRCLE & PLINTH

custom made items also available

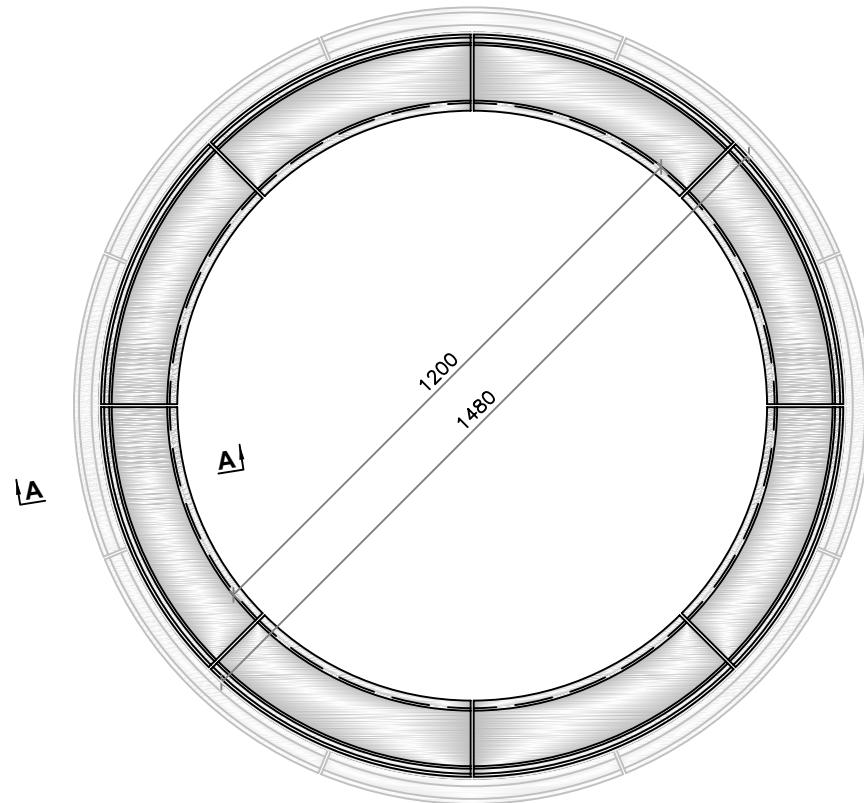

**Plan View**

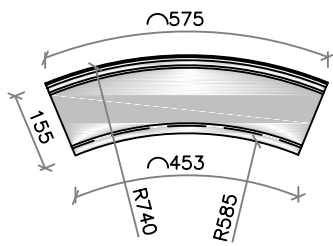

**Kerb Detail**

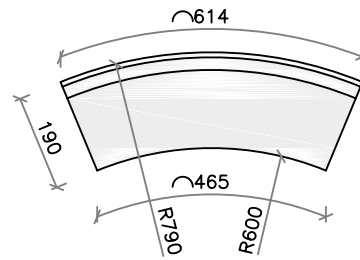

**Plinth Detail**

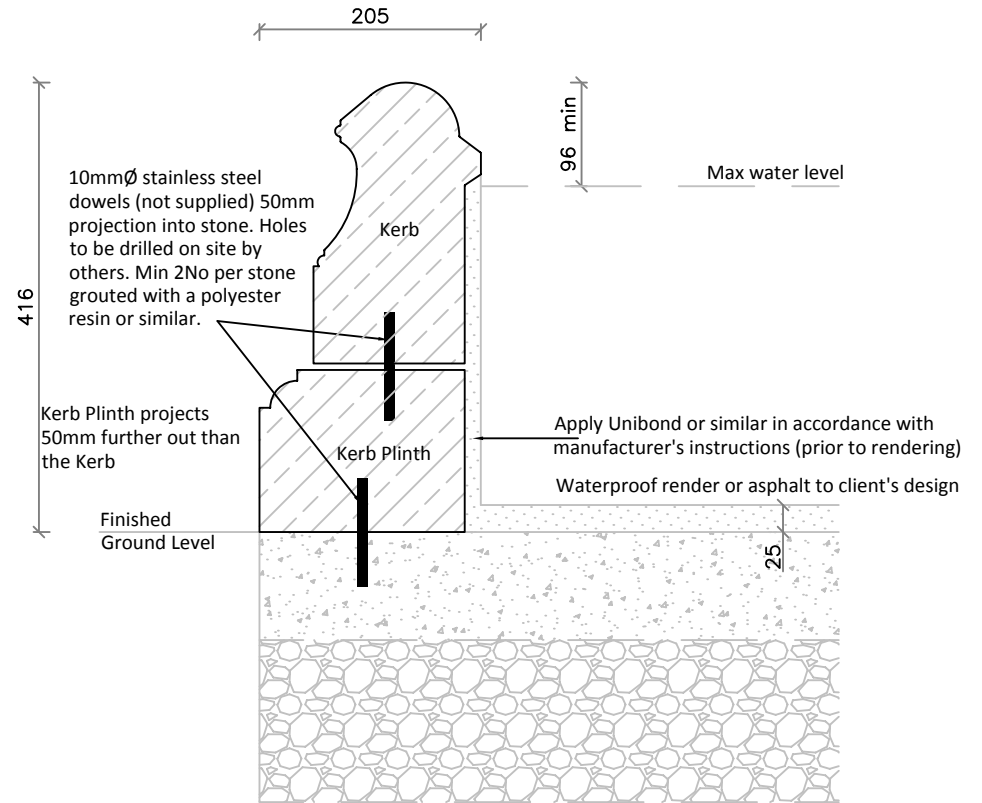

To guard against frost damage, drain off the water at the beginning of November and do not replace it until the hard frost are past in the following spring  
Unless otherwise stated, all materials other than stonework are to be supplied by others.

Allow 6mm for vertical and bedding joints unless otherwise stated

Fibre glass liner available for this pool surround.

info@acanthuscaststone.co.uk

01773 540704

www.acanthuscaststone.co.uk

# ACANTHUS

cast stone products

## POOL SURROUND - PS10C SMALL FULL CIRCLE

custom made items also available

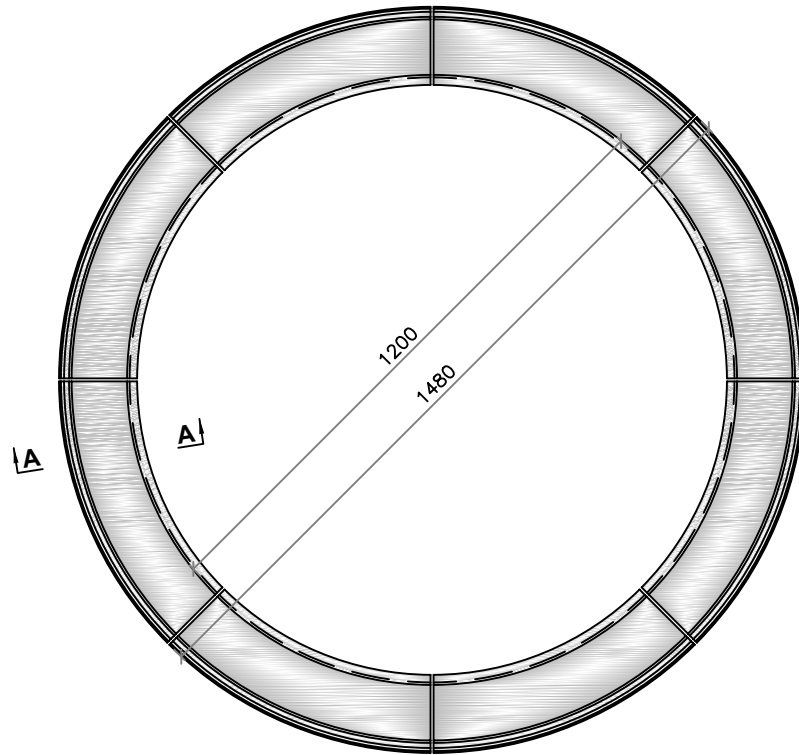

Plan View

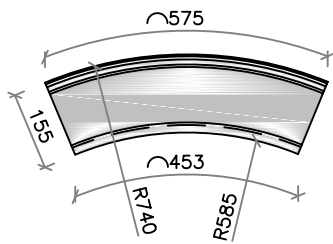

Kerb Detail

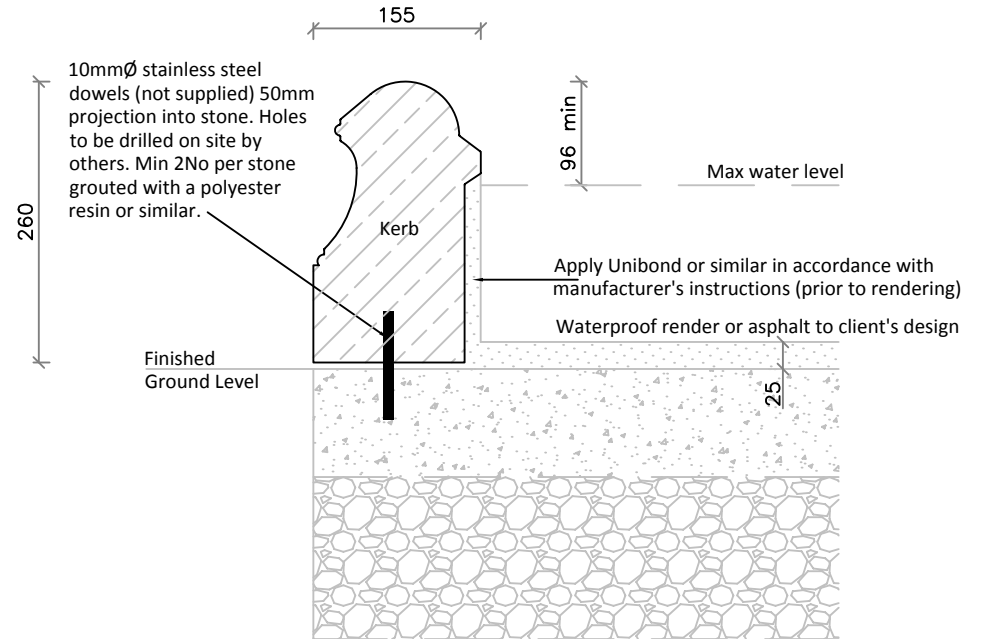

To guard against frost damage, drain off the water at the beginning of November and do not replace it until the hard frost are past in the following spring

Unless otherwise stated, all materials other than stonework are to be supplied by others.

Allow 6mm for vertical and bedding joints unless otherwise stated

Fibre glass liner available for this pool surround.

[info@acanthuscaststone.co.uk](mailto:info@acanthuscaststone.co.uk)

01773 540704

[www.acanthuscaststone.co.uk](http://www.acanthuscaststone.co.uk)

# ACANTHUS

cast stone products

## POOL SURROUND - PS10HCP SMALL HALF CIRCLE & PLINTH

custom made items also available

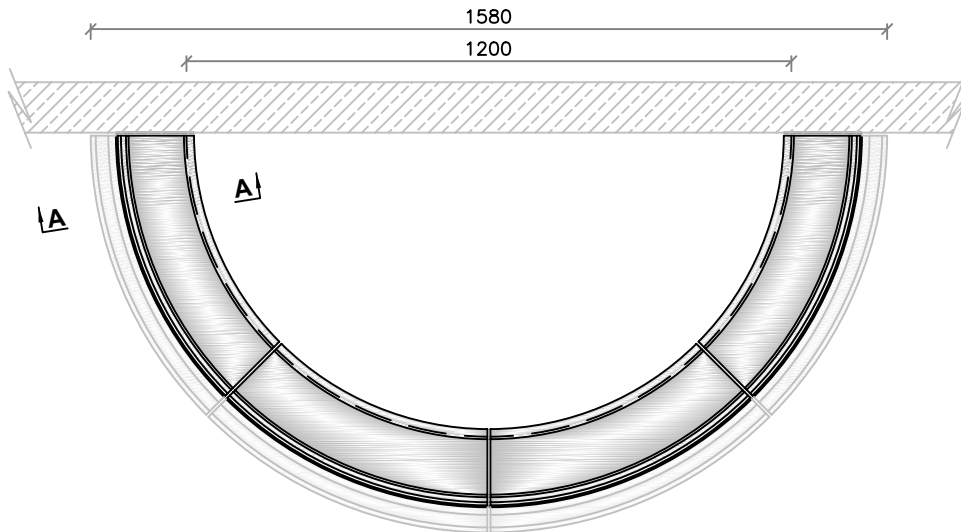

Plan View

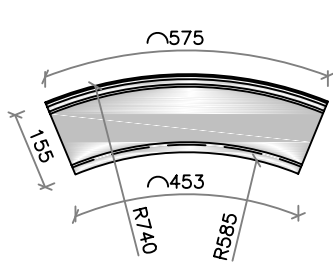

Kerb Detail

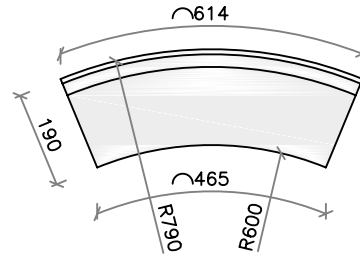

Plinth Detail

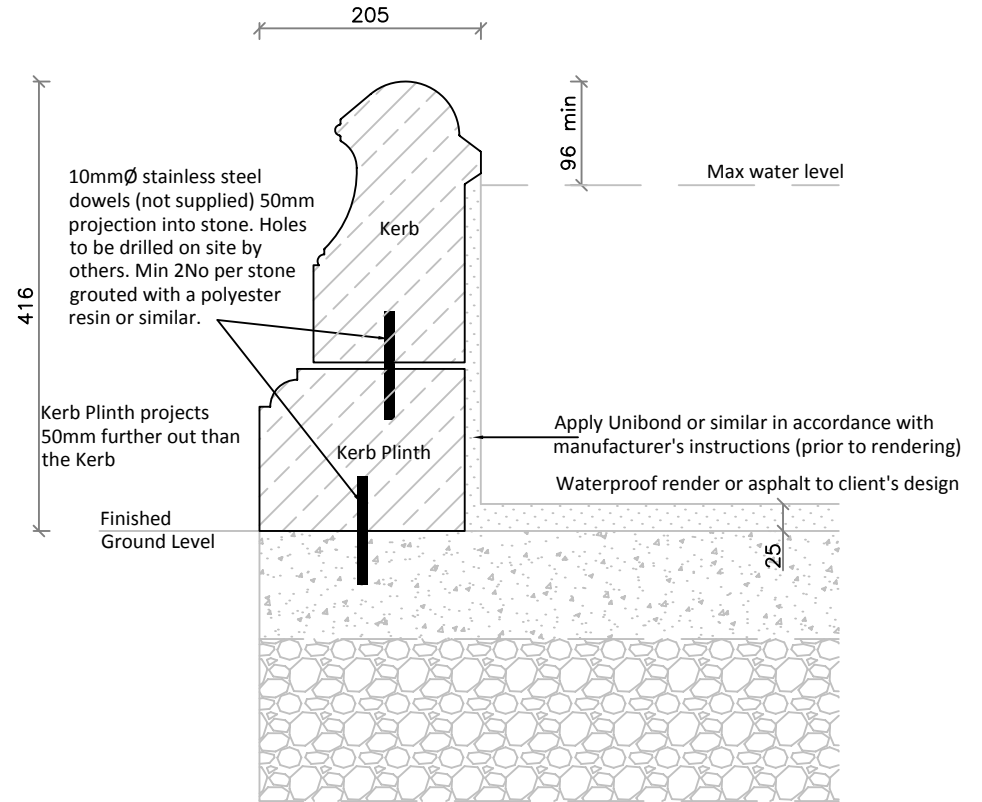

To guard against frost damage, drain off the water at the beginning of November and do not replace it until the hard frost are past in the following spring

Unless otherwise stated, all materials other than stonework are to be supplied by others.

Allow 6mm for vertical and bedding joints unless otherwise stated

Fibre glass liner available for this pool surround.

info@acanthuscaststone.co.uk

01773 540704

www.acanthuscaststone.co.uk

# ACANTHUS

cast stone products

## POOL SURROUND - PS10HC SMALL HALF CIRCLE

custom made items also available

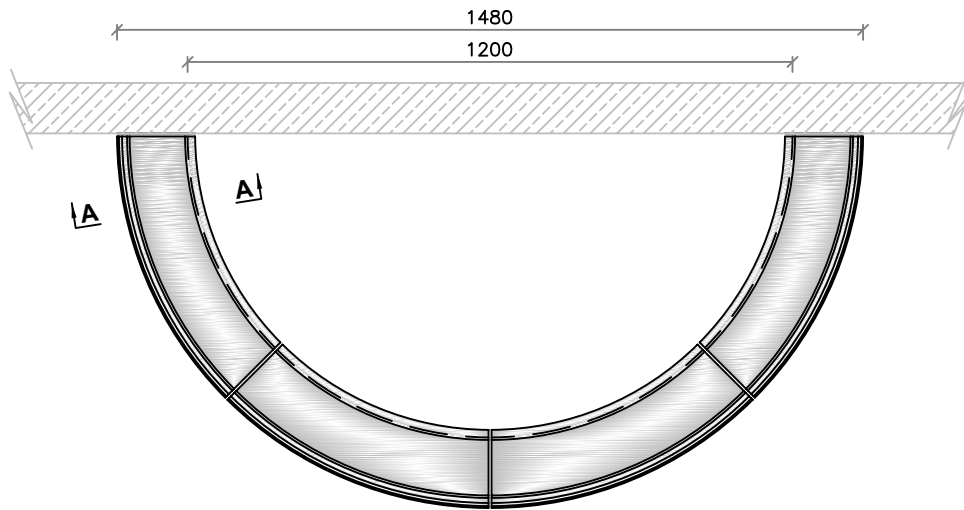

Plan View

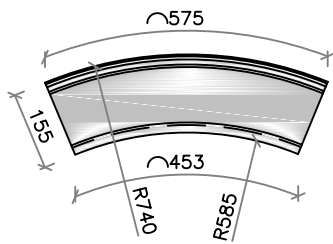

Kerb Detail

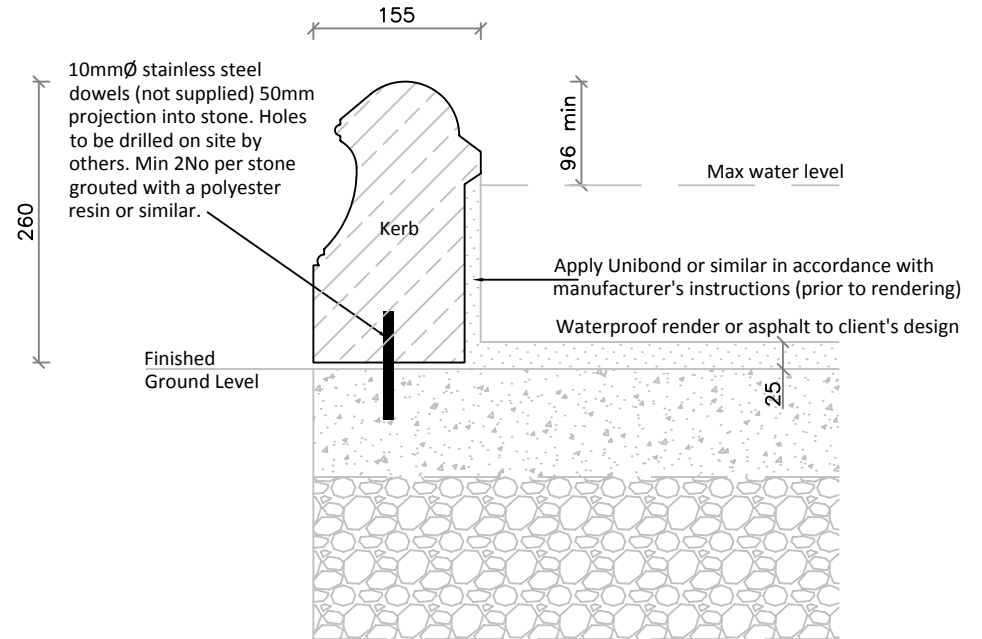

To guard against frost damage, drain off the water at the beginning of November and do not replace it until the hard frost are past in the following spring

Unless otherwise stated, all materials other than stonework are to be supplied by others.

Allow 6mm for vertical and bedding joints unless otherwise stated

Fibre glass liner available for this pool surround.

info@acanthuscaststone.co.uk

01773 540704

www.acanthuscaststone.co.uk

# ACANTHUS

cast stone products

## POOL SURROUND - PS20CP MEDIUM FULL CIRCLE & PLINTH

custom made items also available

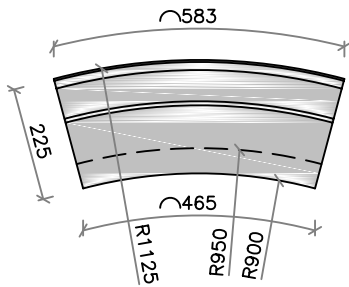
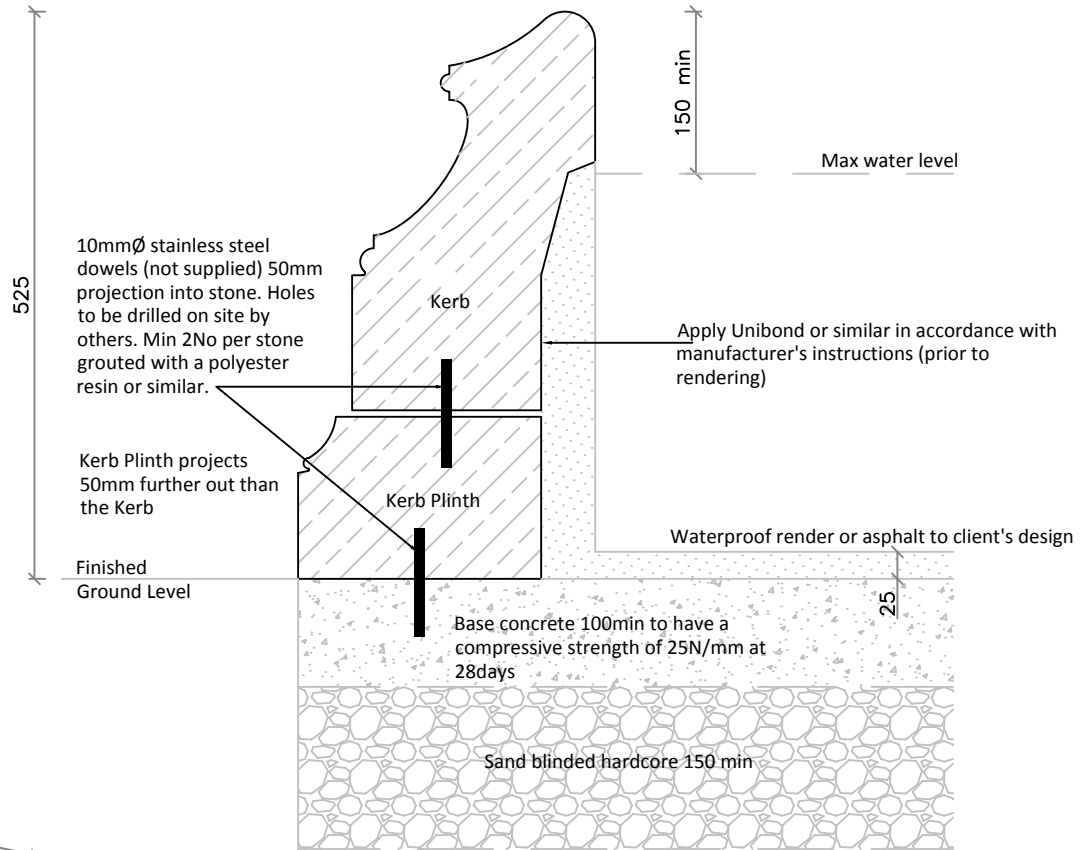
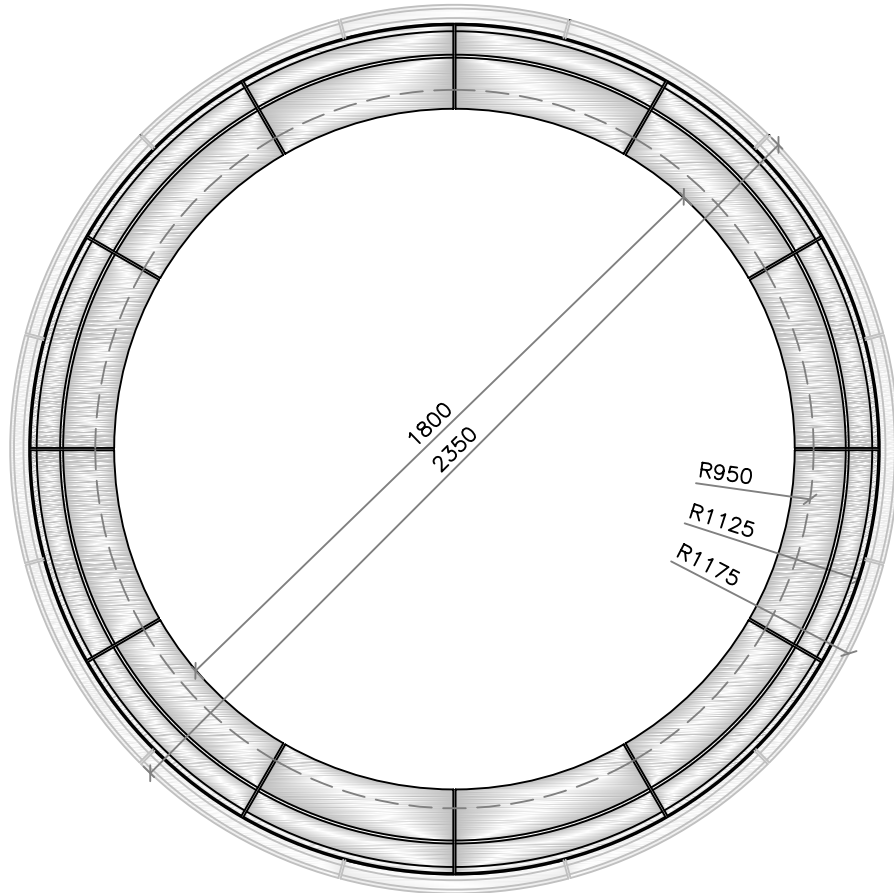

Kerb Detail

Plan View

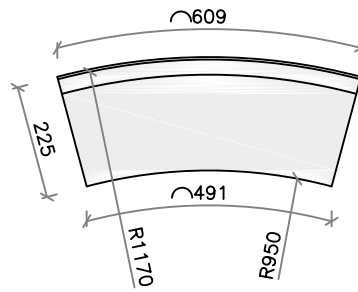

Plinth Detail

To guard against frost damage, drain off the water at the beginning of November and do not replace it until the hard frosts are past in the following spring. Unless otherwise stated, all materials other than stonework are to be supplied by others.

Allow 6mm for vertical and bedding joints unless otherwise stated

Fibre glass liner available for this pool surround.

info@acanthuscaststone.co.uk

01773 540704

www.acanthuscaststone.co.uk

# ACANTHUS

cast stone products

## POOL SURROUND - PS20C MEDIUM FULL CIRCLE

custom made items also available

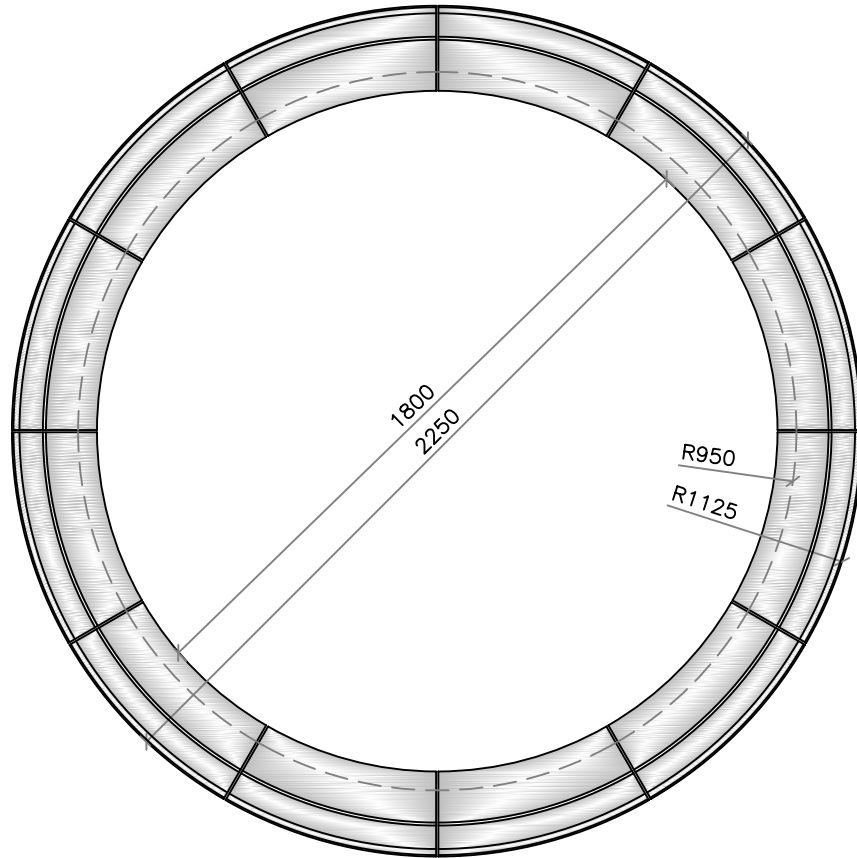

Plan View

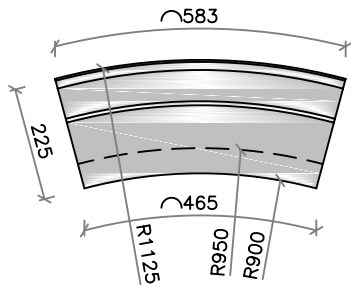

Kerb Detail

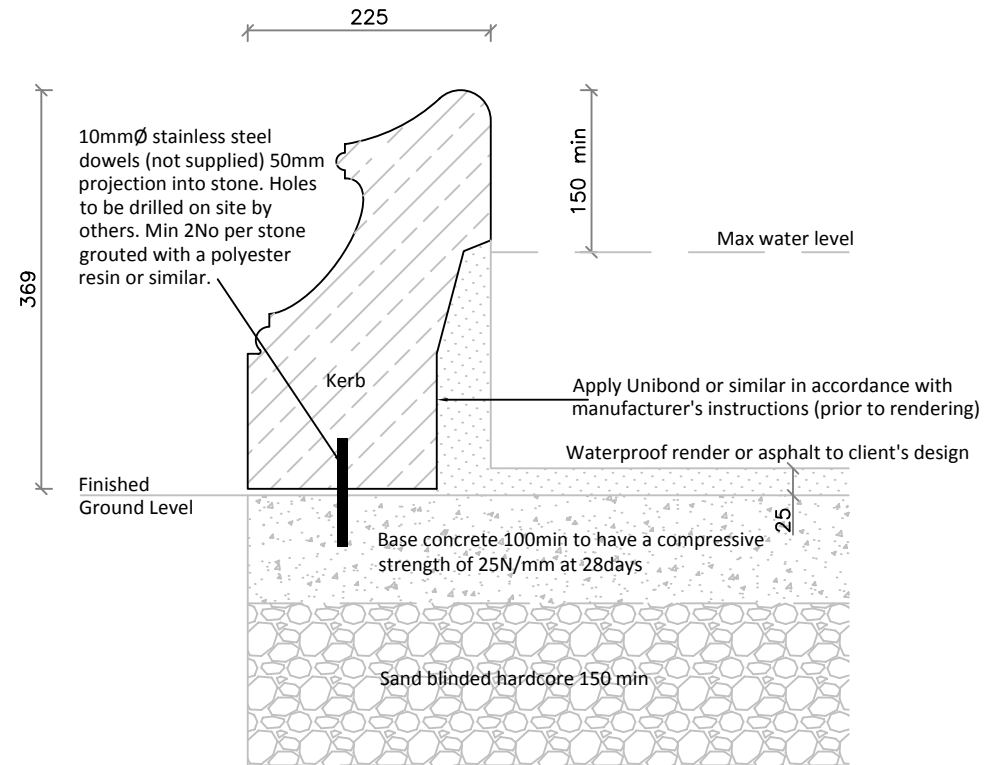

To guard against frost damage, drain off the water at the beginning of November and do not replace it until the hard frost are past in the following spring

Unless otherwise stated, all materials other than stonework are to be supplied by others.

Allow 6mm for vertical and bedding joints unless otherwise stated

Fibre glass liner available for this pool surround.

info@acanthuscaststone.co.uk

01773 540704

www.acanthuscaststone.co.uk

# ACANTHUS

cast stone products

## POOL SURROUND - PS20HCP MEDIUM HALF CIRCLE & PLINTH

custom made items also available

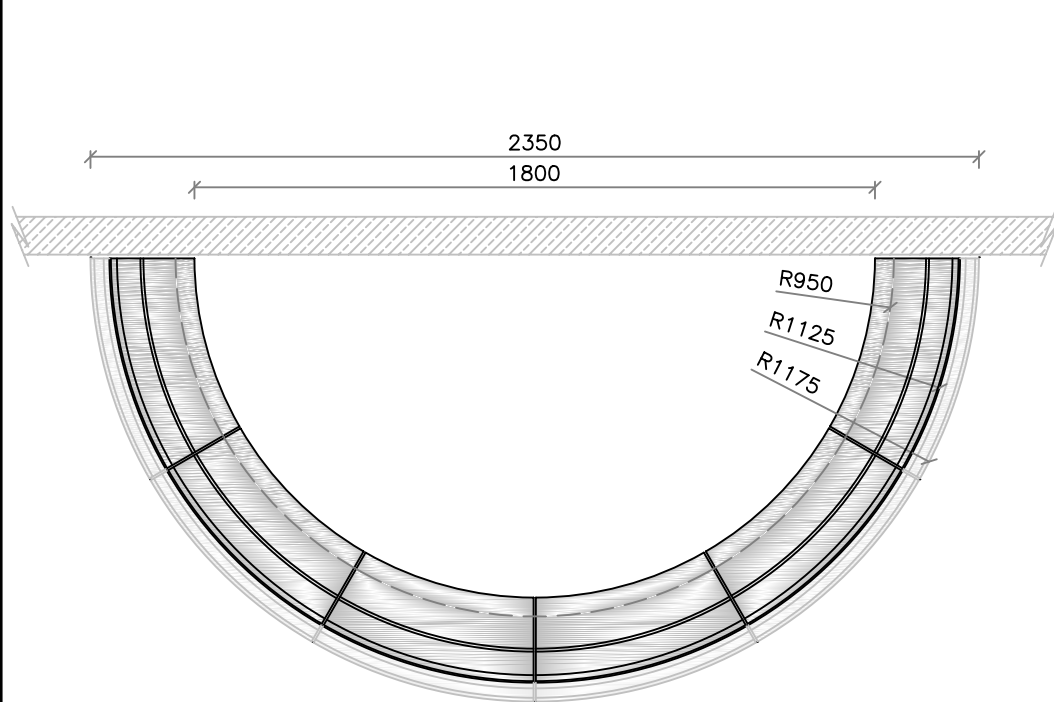

**Plan View**

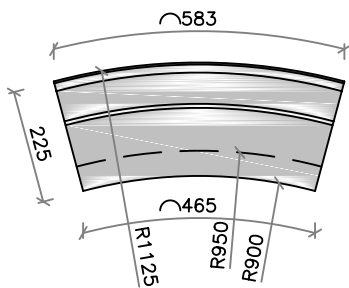

**Kerb Detail**

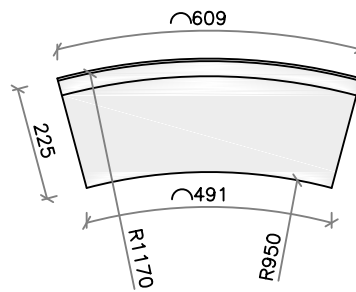

**Plinth Detail**

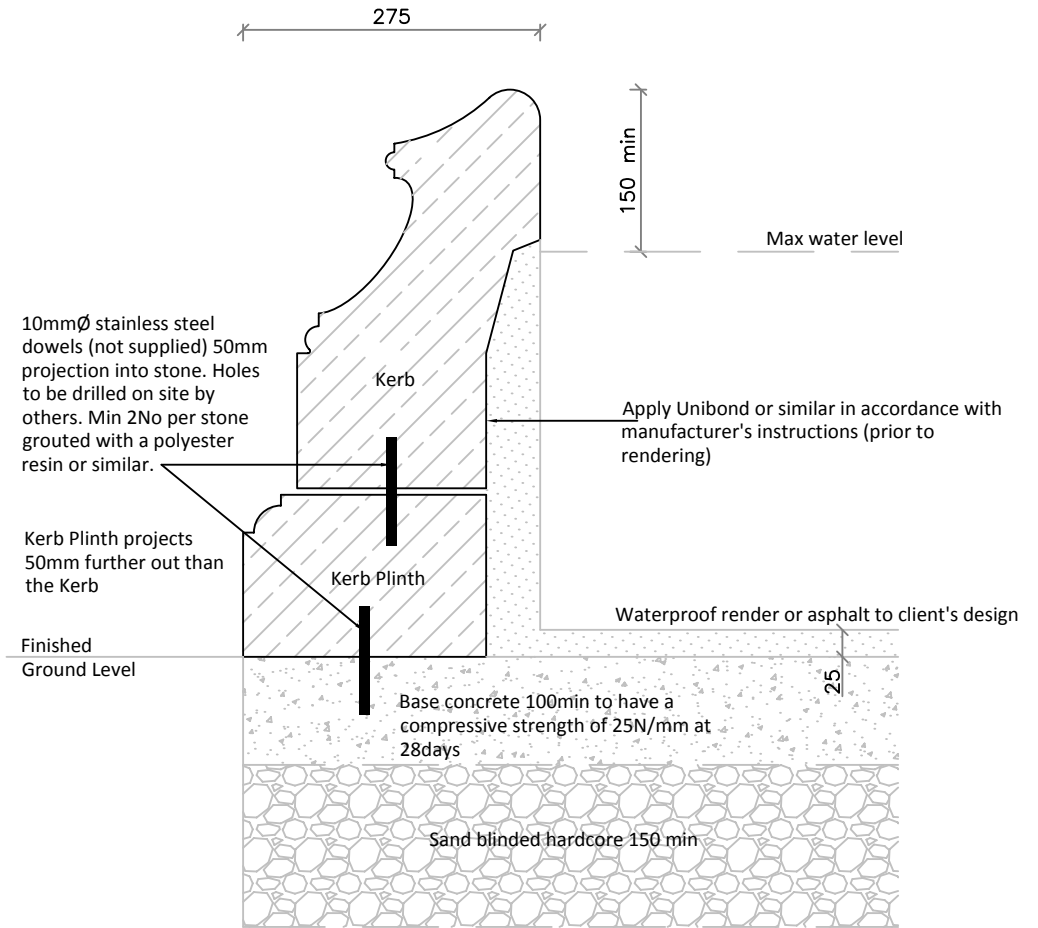

To guard against frost damage, drain off the water at the beginning of November and do not replace it until the hard frost are past in the following spring  
Unless otherwise stated, all materials other than stonework are to be supplied by others.

Allow 6mm for vertical and bedding joints unless otherwise stated

Fibre glass liner available for this pool surround.

info@acanthuscaststone.co.uk

01773 540704

www.acanthuscaststone.co.uk

# ACANTHUS

cast stone products

## POOL SURROUND - PS20HC MEDIUM HALF CIRCLE

custom made items also available

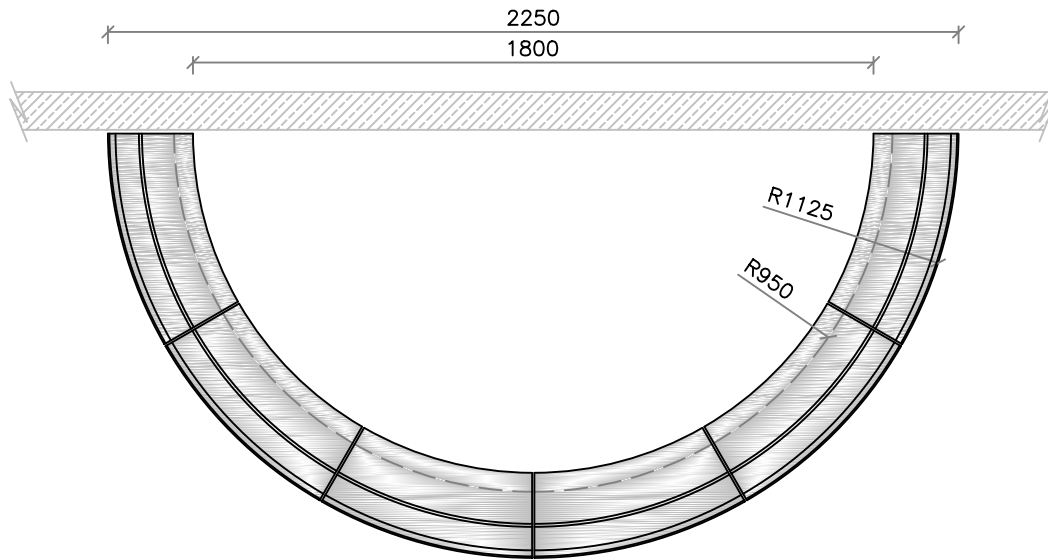

Plan View

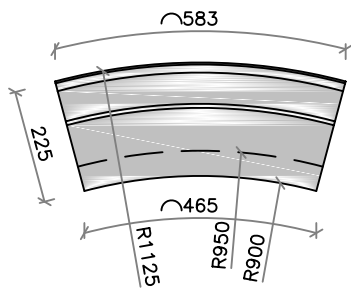

Kerb Detail

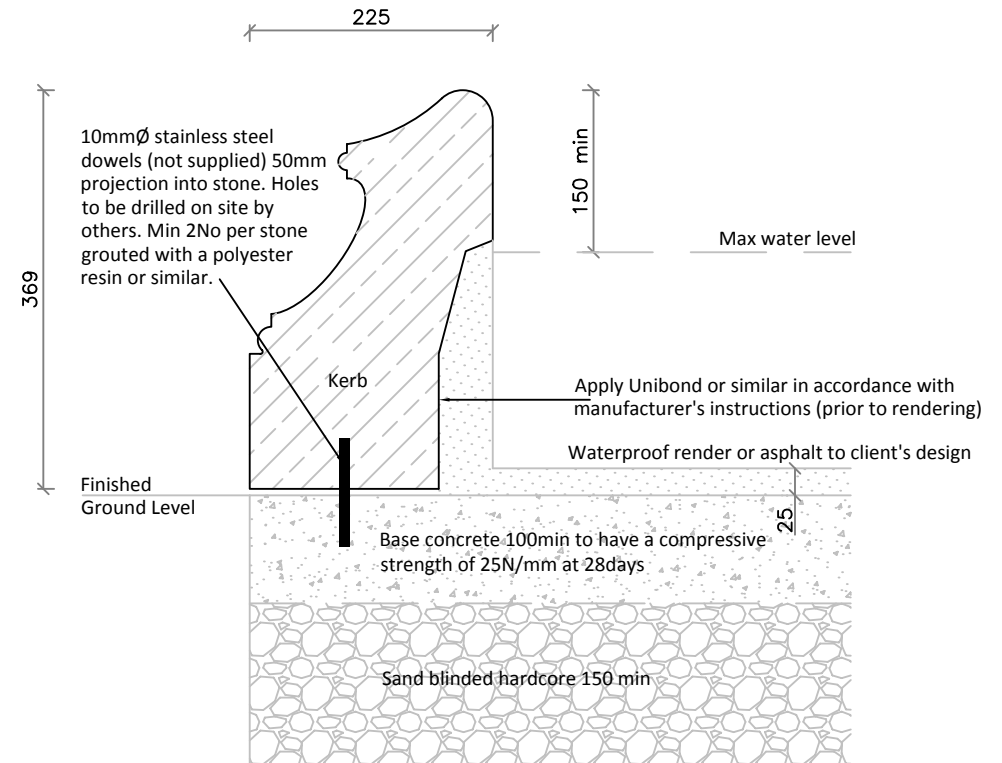

To guard against frost damage, drain off the water at the beginning of November and do not replace it until the hard frost are past in the following spring

Unless otherwise stated, all materials other than stonework are to be supplied by others.

Allow 6mm for vertical and bedding joints unless otherwise stated

Fibre glass liner available for this pool surround.

info@acanthuscaststone.co.uk

01773 540704

www.acanthuscaststone.co.uk



# ACANTHUS

cast stone products

## POOL SURROUND - PS20SQ9 MEDIUM SQUARE & PLINTH

custom made items also available

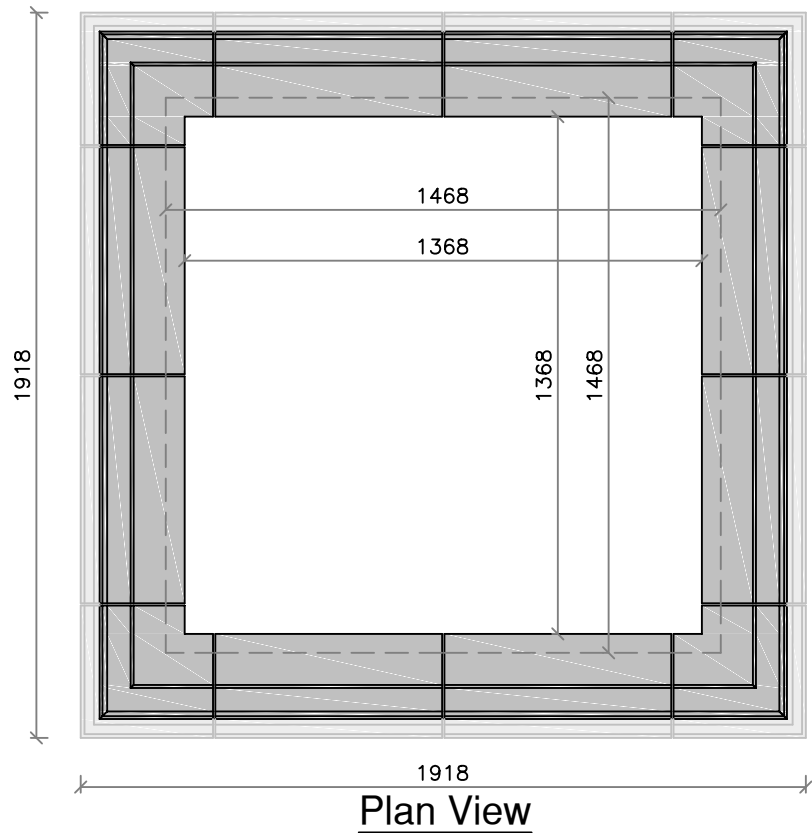

**Plan View**

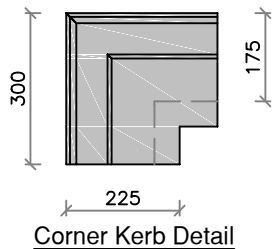

**Corner Kerb Detail**

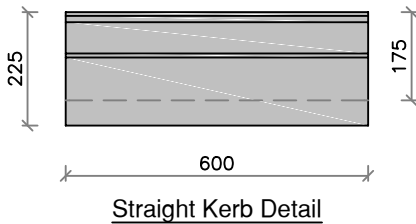

**Straight Kerb Detail**

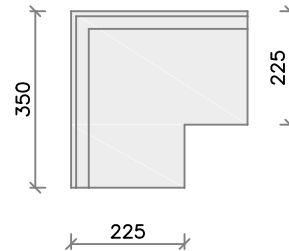

**Corner Plinth Detail**

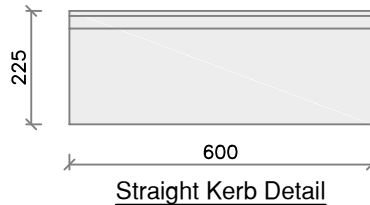

**Straight Kerb Detail**

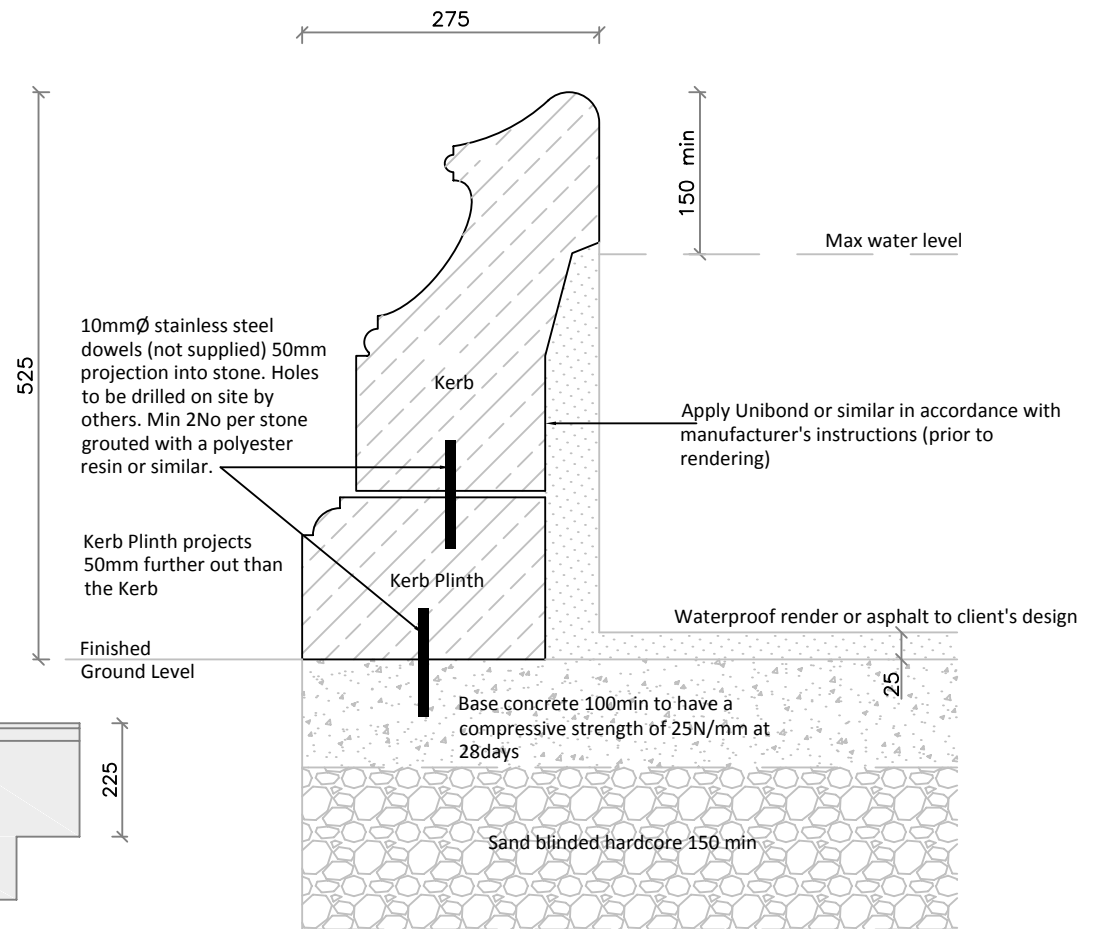

To guard against frost damage, drain off the water at the beginning of November and do not replace it until the hard frost are past in the following spring  
Unless otherwise stated, all materials other than stonework are to be supplied by others.

Allow 6mm for vertical and bedding joints unless otherwise stated

Fibre glass liner available for this pool surround.

info@acanthuscaststone.co.uk

01773 540704

www.acanthuscaststone.co.uk

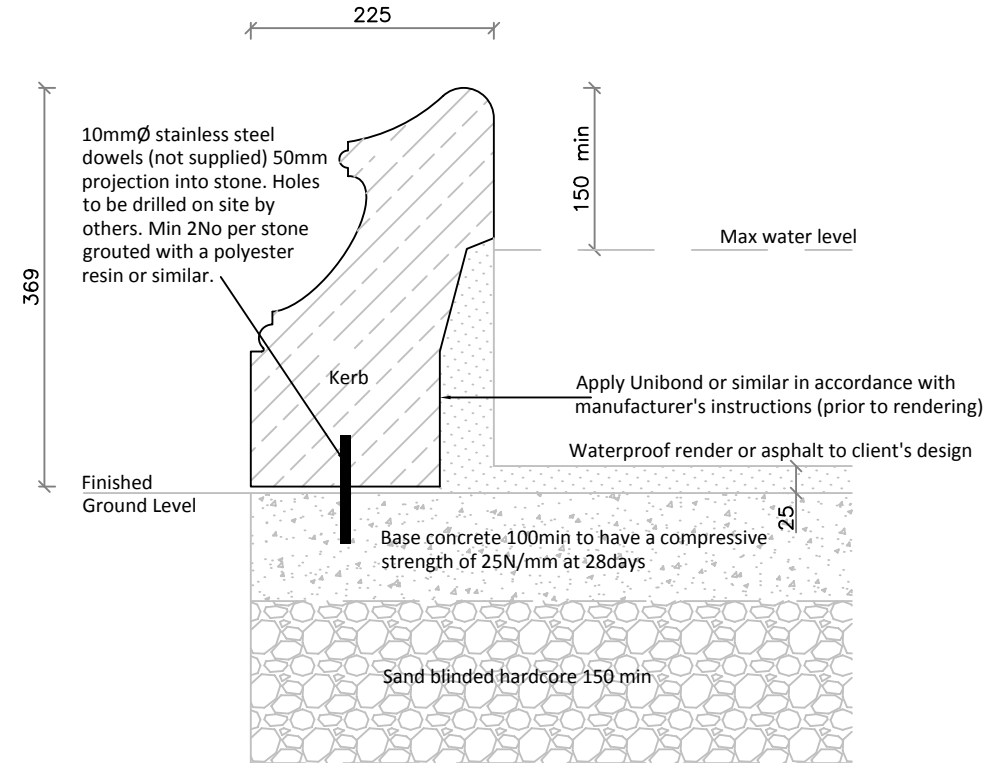
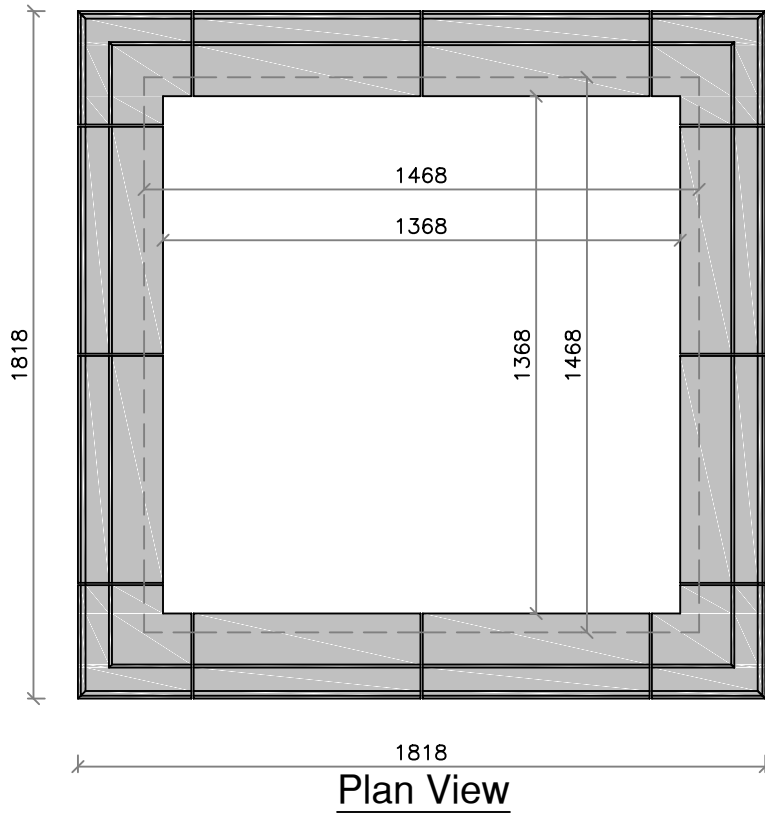

To guard against frost damage, drain off the water at the beginning of November and do not replace it until the hard frost are past in the following spring  
Unless otherwise stated, all materials other than stonework are to be supplied by others.  
Allow 6mm for vertical and bedding joints unless otherwise stated

Fibre glass liner available for this pool surround.

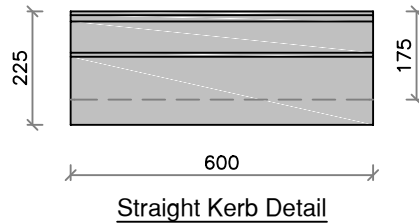
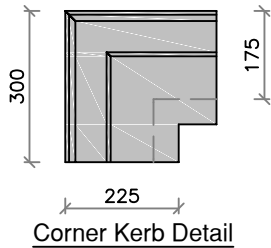

# ACANTHUS

cast stone products

## POOL SURROUND - PS30CP LARGE FULL CIRCLE & PLINTH

custom made items also available

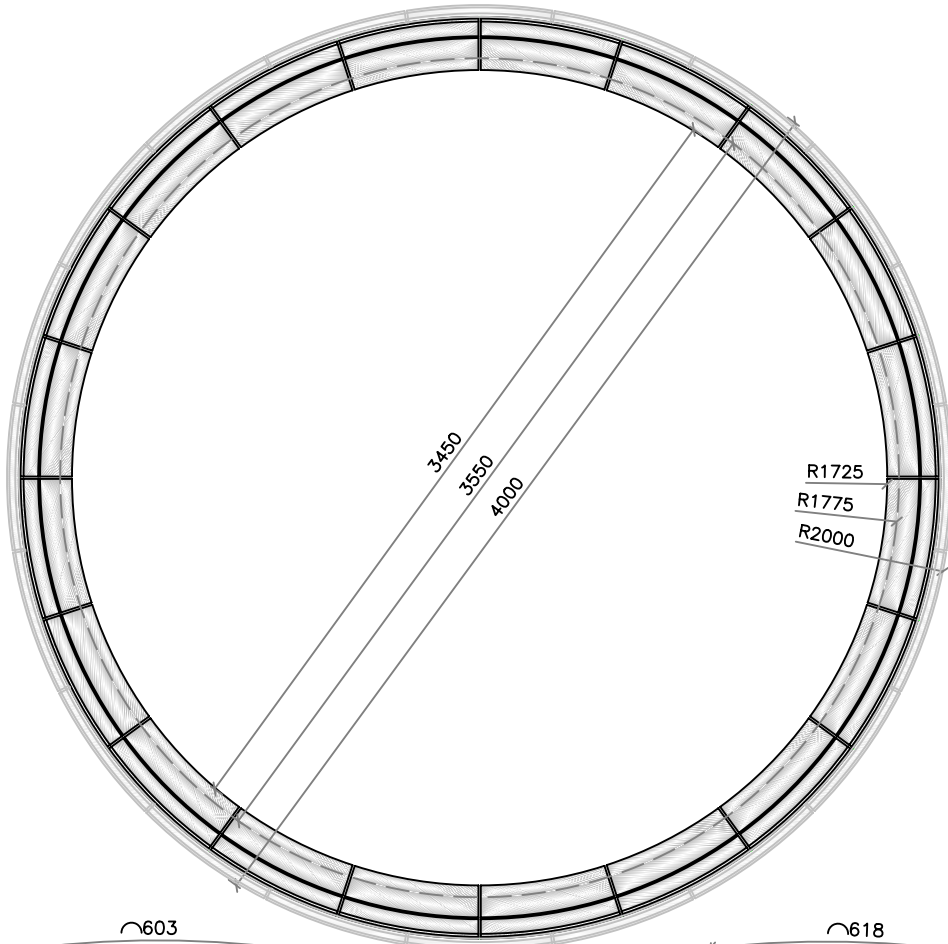

Plan View

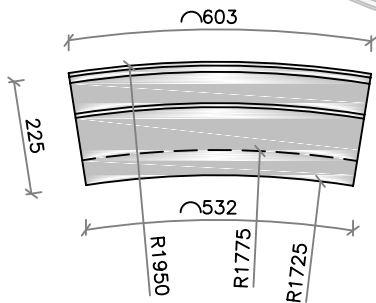

Kerb Detail

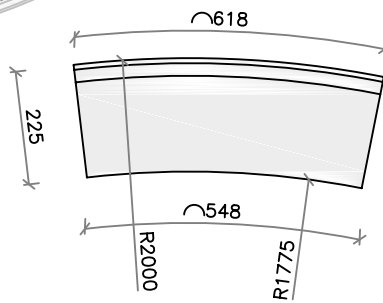

Plinth Detail

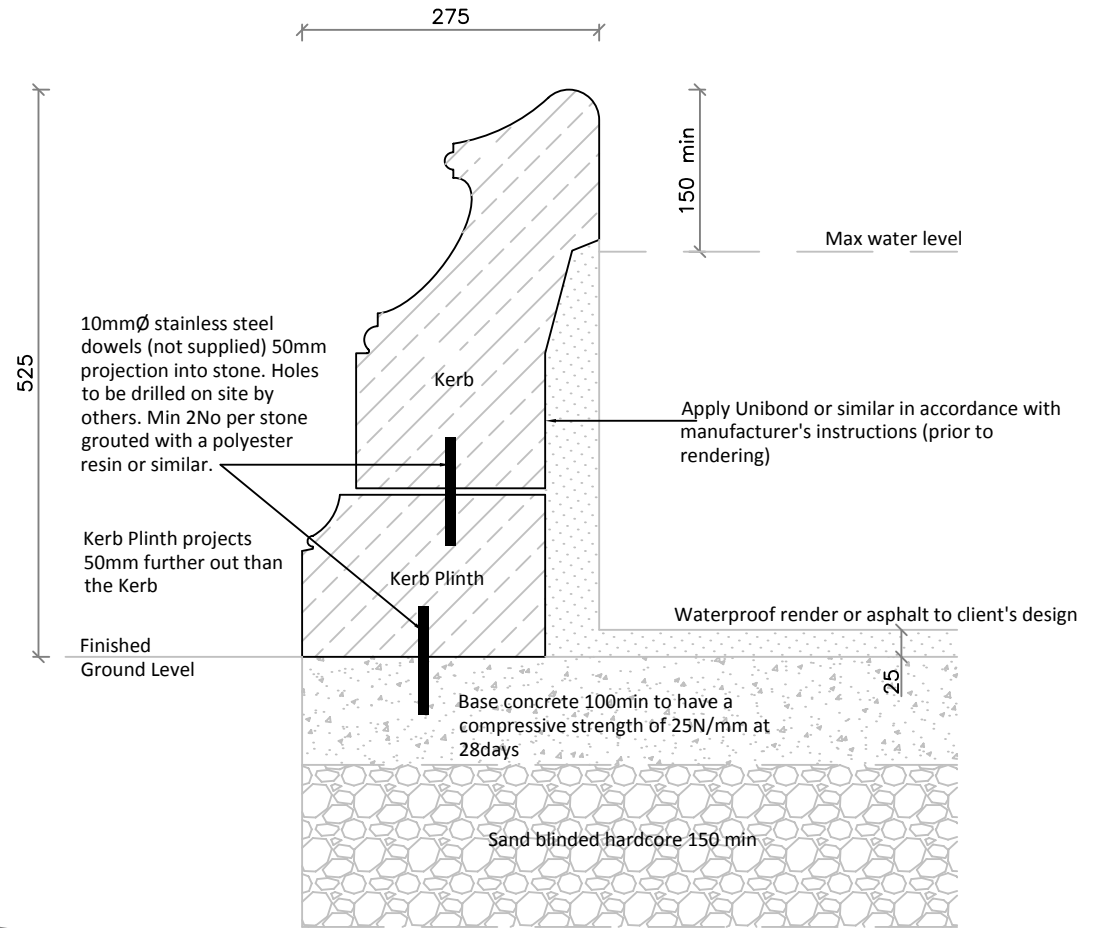

To guard against frost damage, drain off the water at the beginning of November and do not replace it until the hard frost are past in the following spring  
Unless otherwise stated, all materials other than stonework are to be supplied by others.

**Allow 10mm for vertical and 6mm for bedding joints unless otherwise stated**

Fibre glass liner available for this pool surround.

info@acanthuscaststone.co.uk

01773 540704

www.acanthuscaststone.co.uk

# ACANTHUS

cast stone products

## POOL SURROUND - PS30C LARGE FULL CIRCLE

custom made items also available

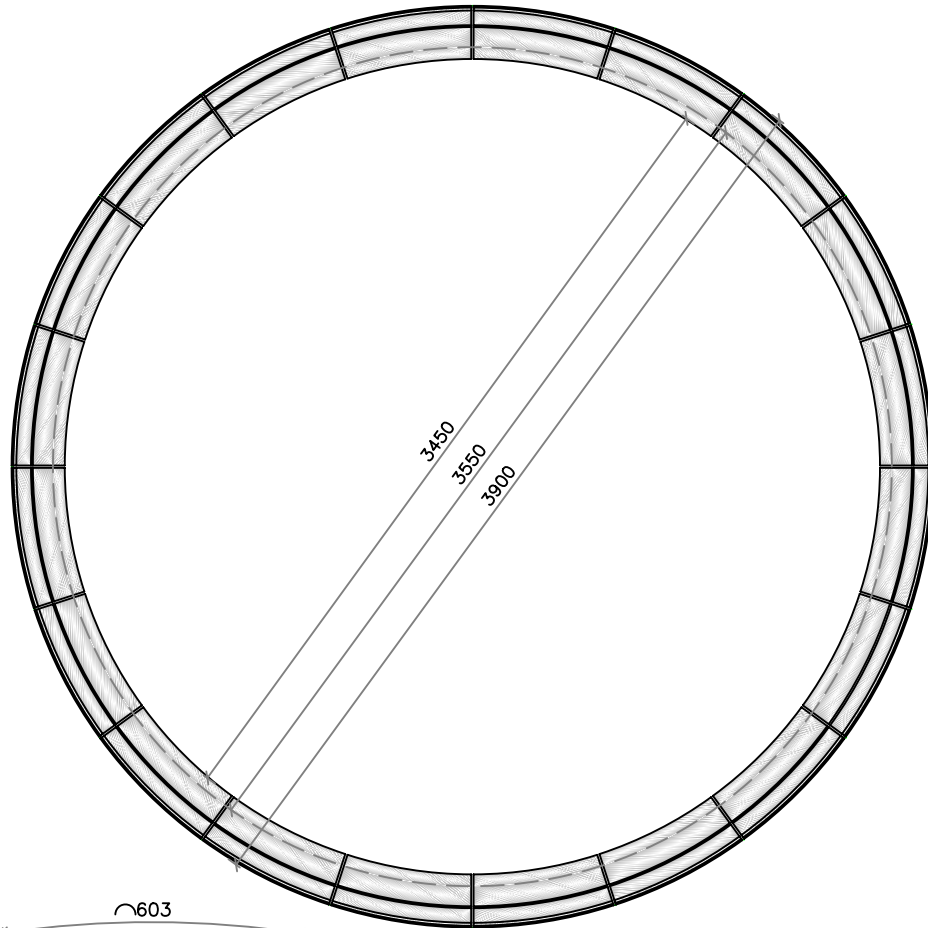

Plan View

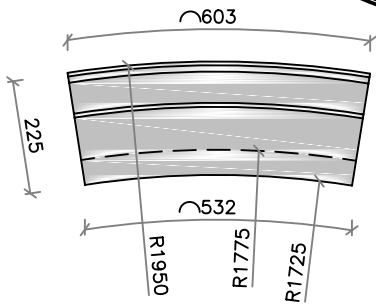

Kerb Detail

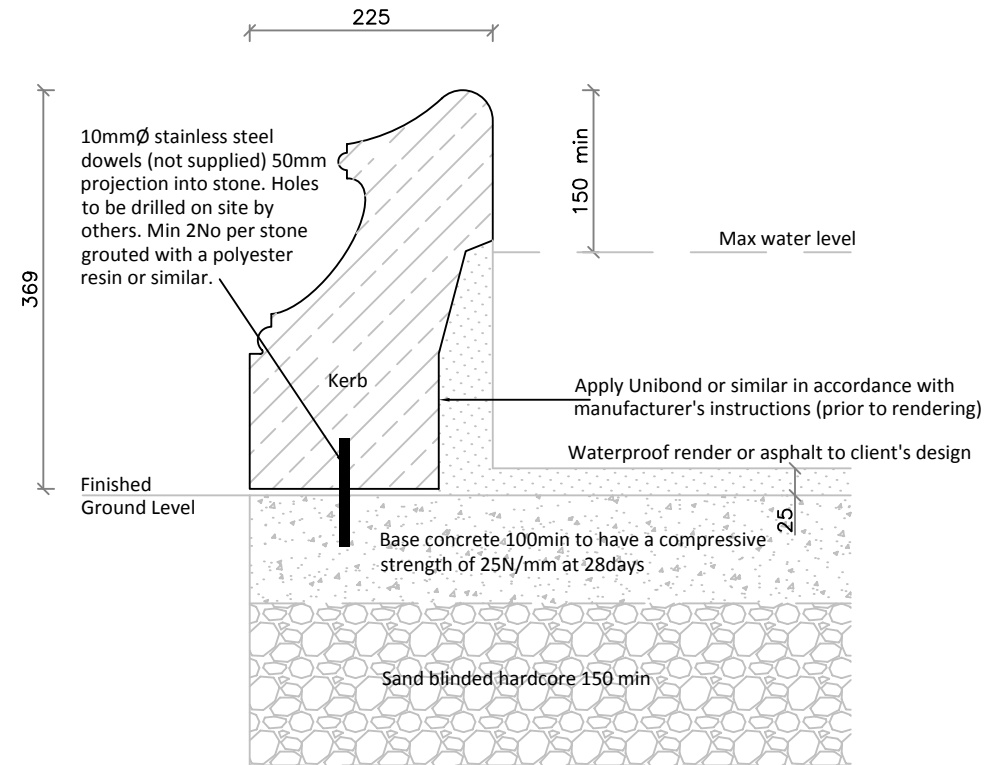

To guard against frost damage, drain off the water at the beginning of November and do not replace it until the hard frost are past in the following spring  
Unless otherwise stated, all materials other than stonework are to be supplied by others.

**Allow 10mm for vertical and 6mm for bedding joints unless otherwise stated**

Fibre glass liner available for this pool surround.

info@acanthuscaststone.co.uk

01773 540704

www.acanthuscaststone.co.uk

# ACANTHUS

cast stone products

## POOL SURROUND - PS30HCP LARGE HALF CIRCLE & PLINTH

custom made items also available

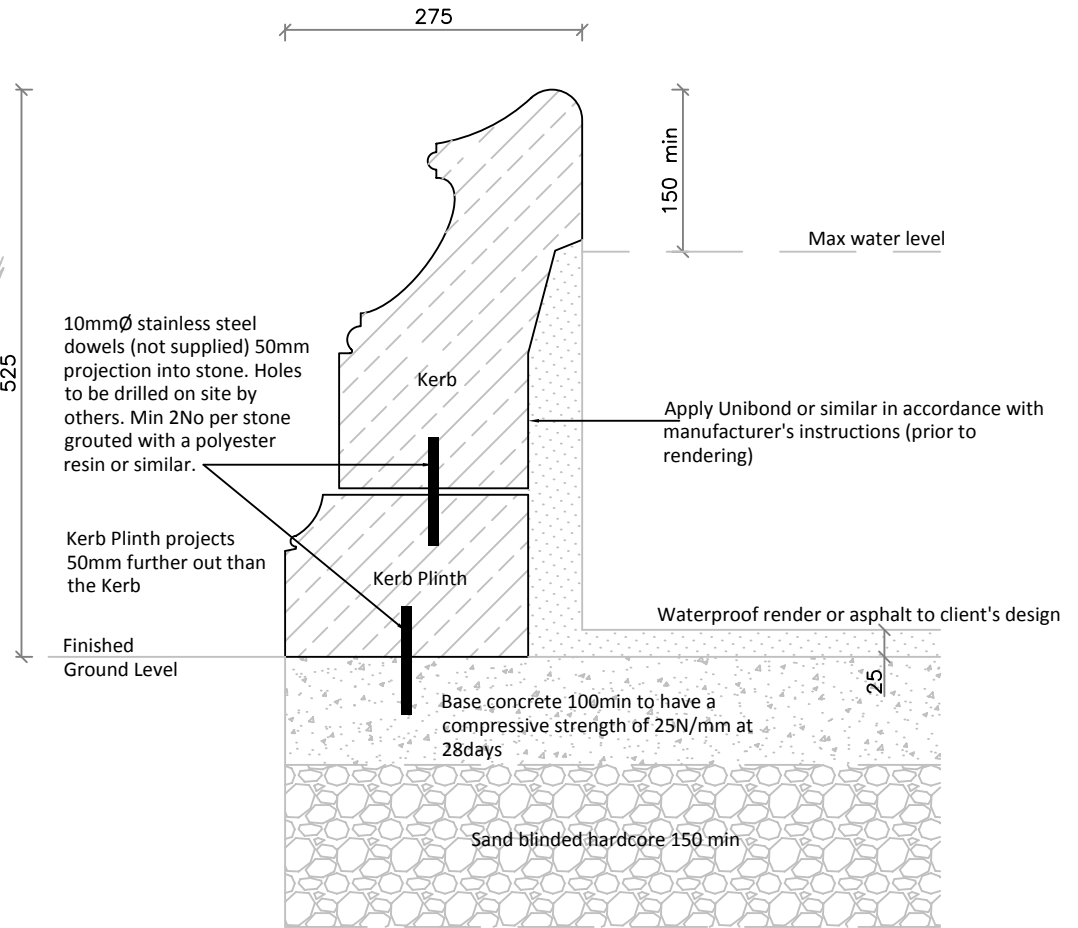
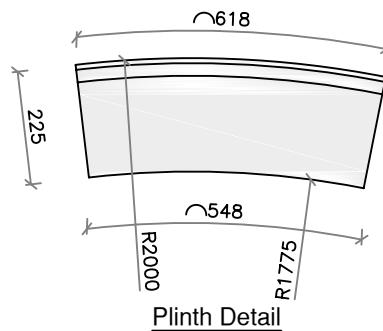
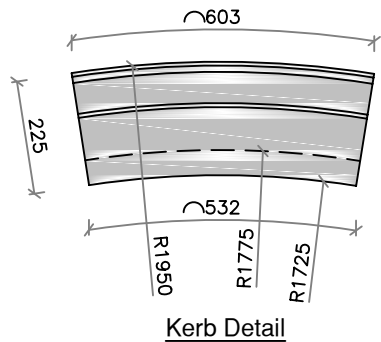
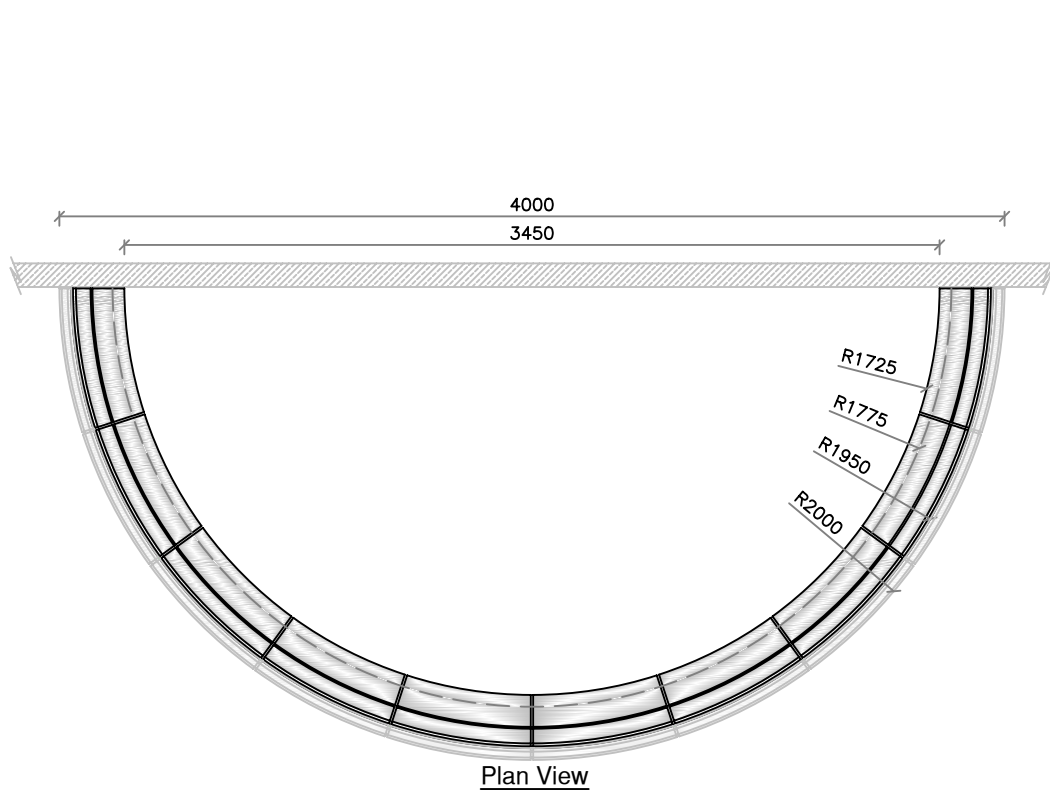

To guard against frost damage, drain off the water at the beginning of November and do not replace it until the hard frost are past in the following spring  
Unless otherwise stated, all materials other than stonework are to be supplied by others.

**Allow 10mm for vertical and 6mm for bedding joints unless otherwise stated**

Fibre glass liner available for this pool surround.

info@acanthuscaststone.co.uk

01773 540704

www.acanthuscaststone.co.uk

# ACANTHUS

cast stone products

## POOL SURROUND - PS30HC LARGE HALF CIRCLE

custom made items also available

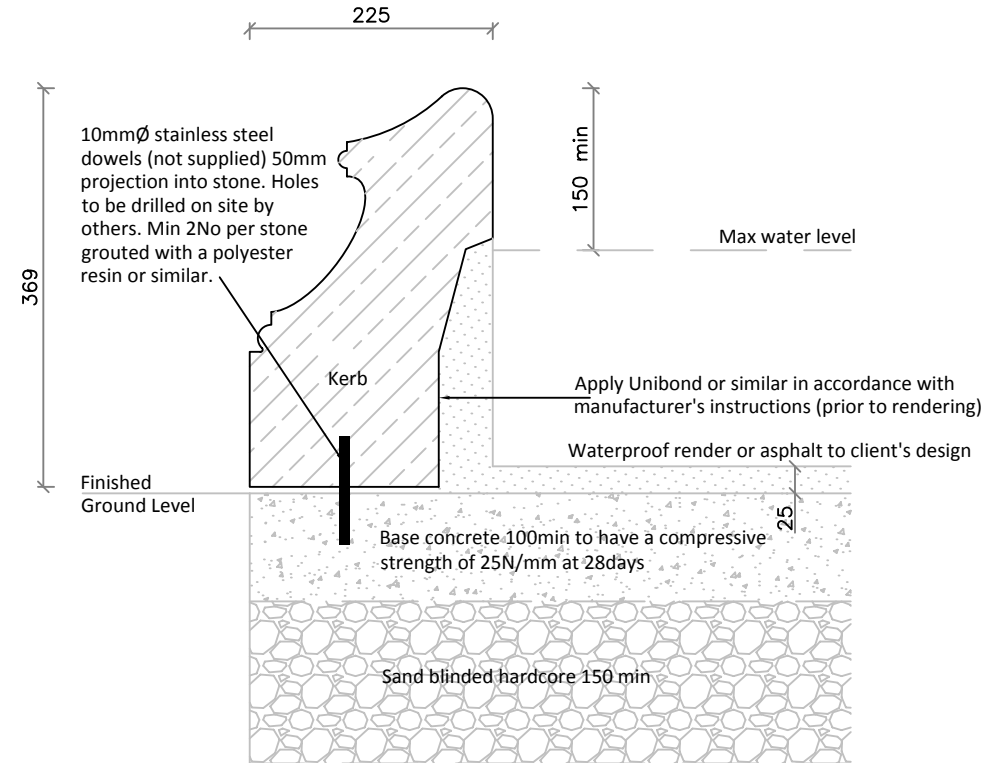
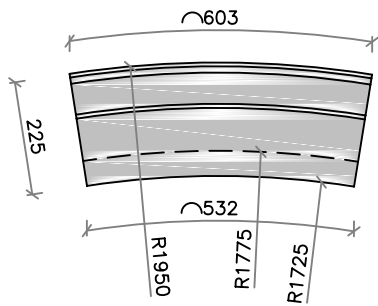
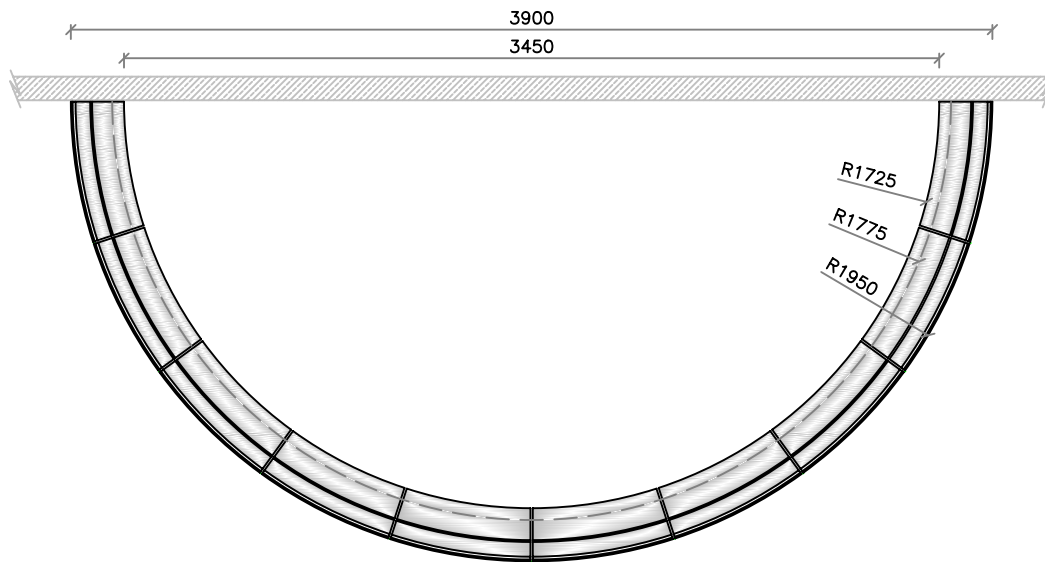

To guard against frost damage, drain off the water at the beginning of November and do not replace it until the hard frost are past in the following spring  
Unless otherwise stated, all materials other than stonework are to be supplied by others.

**Allow 10mm for vertical and 6mm for bedding joints unless otherwise stated**

Fibre glass liner available for this pool surround.

info@acanthuscaststone.co.uk

01773 540704

www.acanthuscaststone.co.uk

# ACANTHUS

cast stone products

## POOL SURROUND - OPTIONS

custom made items also available

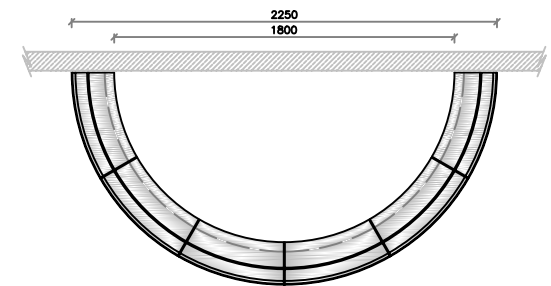
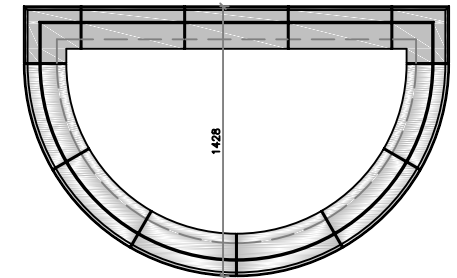
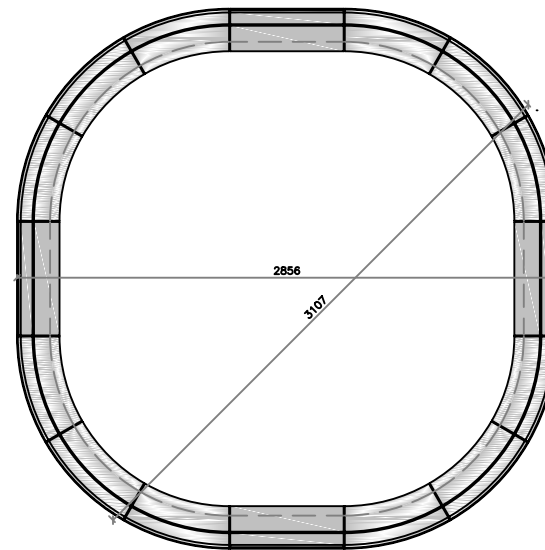
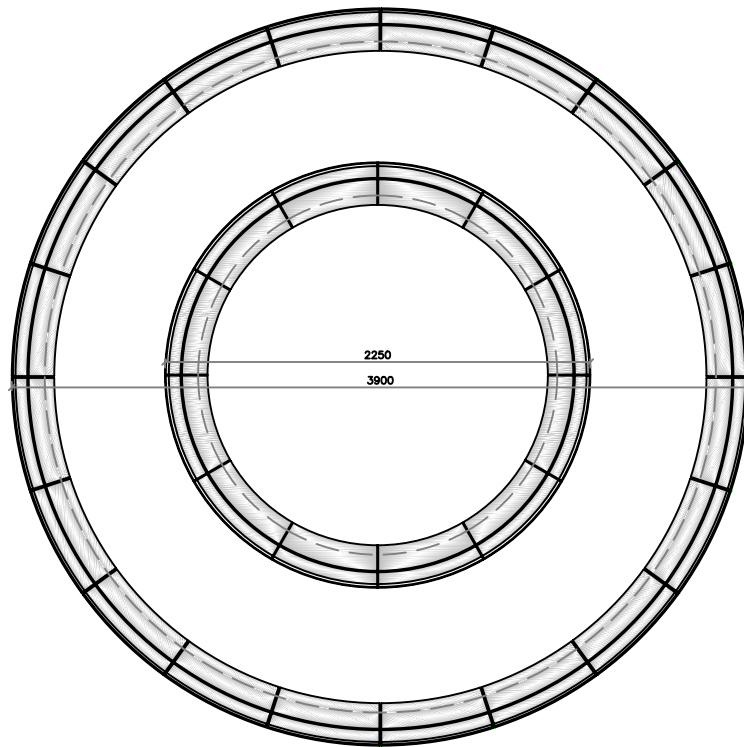
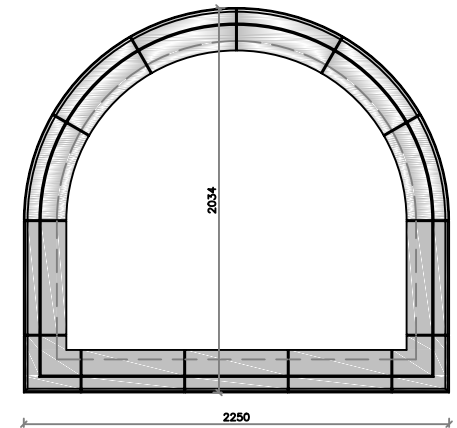
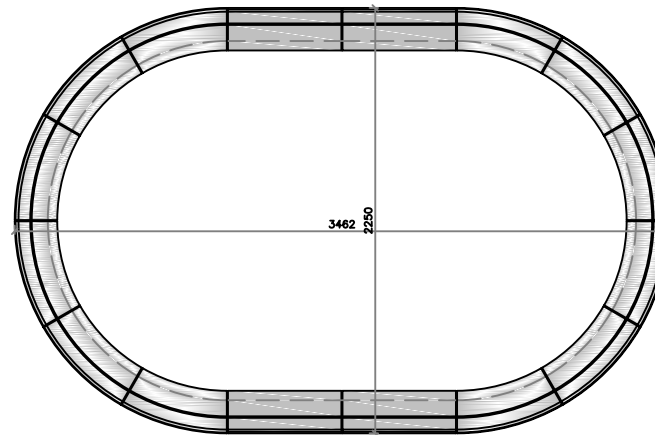
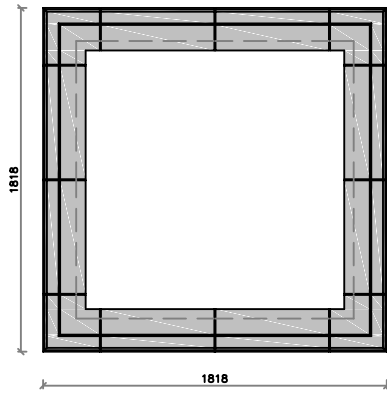
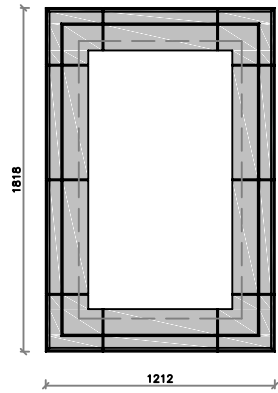

[info@acanthuscaststone.co.uk](mailto:info@acanthuscaststone.co.uk)

01773 540704

[www.acanthuscaststone.co.uk](http://www.acanthuscaststone.co.uk)