

Max length of C1-Imp units are 900mm and C2-Imp to C5-Imp units are 1400mm. Longer units will be manufactured in manageable pieces to suit.

Stool sizes can be adjusted if needed.

C1-Imp Style (19kg/m)

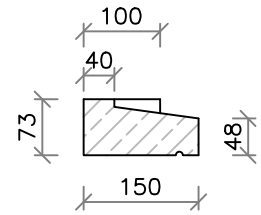
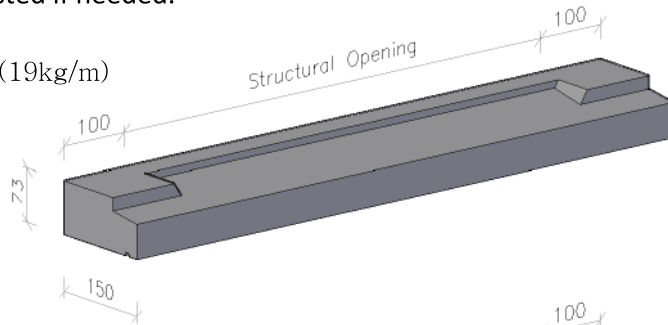

C2-Imp Style (44kg/m)

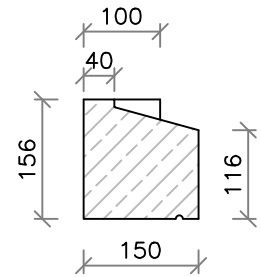
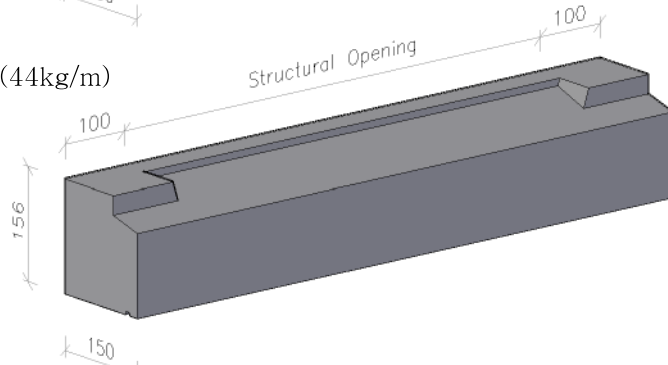

C3-Imp Style (58kg/m)

(Ideal for Sash Windows)

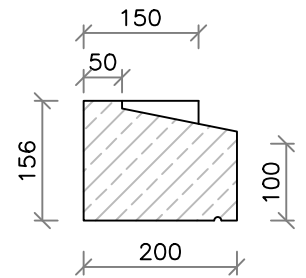
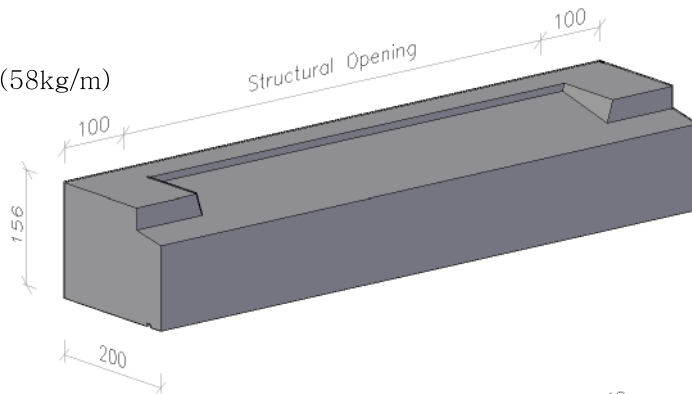

C4-Imp Style (53kg/m)

(Georgian Style)

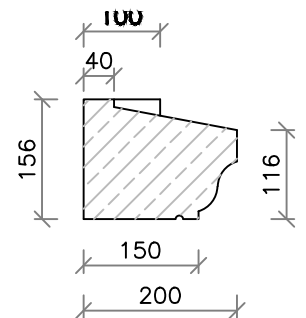
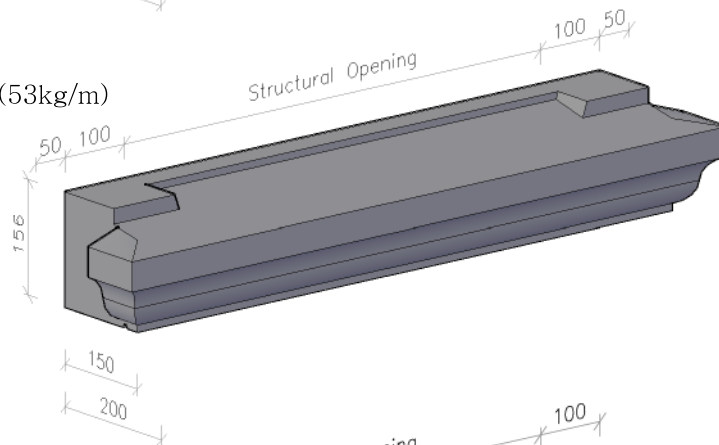

C5-Imp Style (44kg/m)

