

Max length of units are 600mm.

Water drips to underside.

External / Internal units and Stop End units are available.

CS01 (10kg)

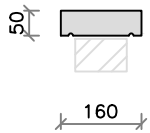

CS02 (13kg)

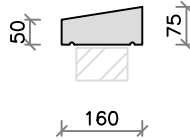

CS03 (16kg)

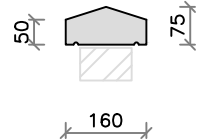

CS04 (13kg)

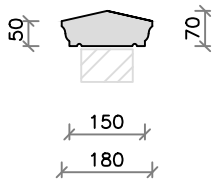

CS04A (15kg)

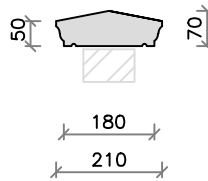

CS04B (10kg)

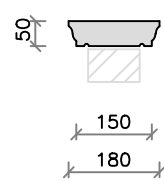

CS04C (12kg)

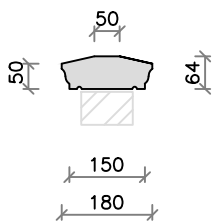

CS05 (12kg)

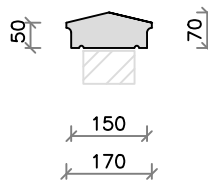

Max length of units are 600mm.

Water drips to underside.

External / Internal units and Stop End units are available.

CS11 (17kg)

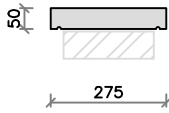

CS11A (19kg)

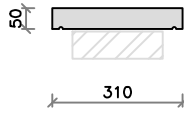

CS12 (22kg)

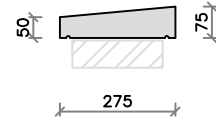

CS12A (24kg)

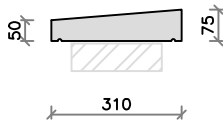

CS13 (22kg)

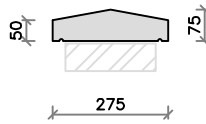

CS13A (24kg)

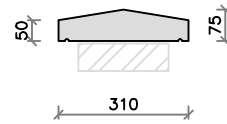

CS14 (31kg)

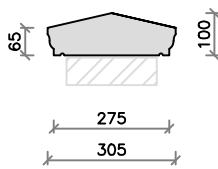

CS14A (34kg)

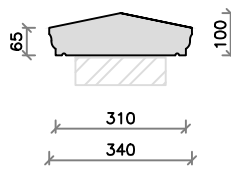

CS14B (24kg)

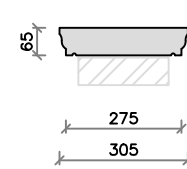

CS14C (30kg)

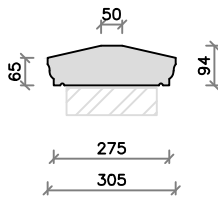

CS15 (29kg)

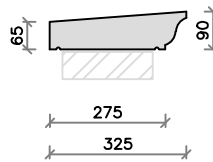

CS16 (35kg)

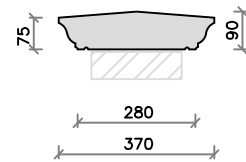

CS17 (37kg)

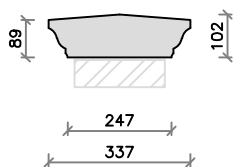

CS18 (41kg)

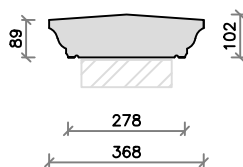

CS19 (25kg)

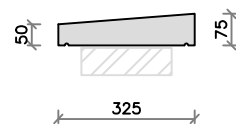

Max length of units are 600mm.

Water drips to underside

External / Internal units and Stop End units are available.

CS20 (24kg)

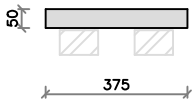

CS21 (25kg)

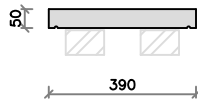

CS22 (31kg)

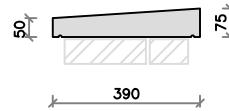

CS23 (30kg)

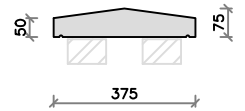

CS24 (30kg)

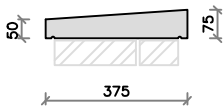

CS31 (37kg)

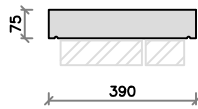

CS32 (32kg)

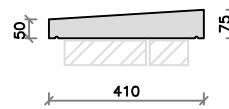

CS33 (31kg)

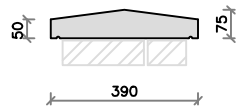

CS34 (45kg)

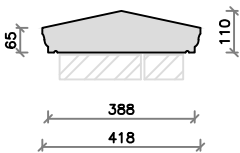

CS34B (33kg)

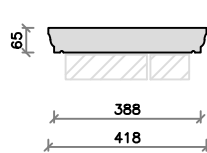

CS34C (45kg)

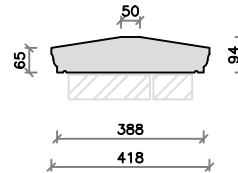

CS35 (46kg)

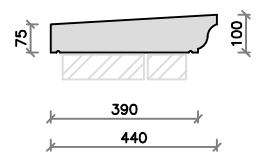

CS28 (47kg)

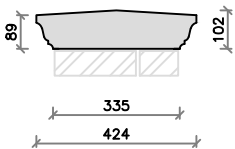

CS37 (56kg)

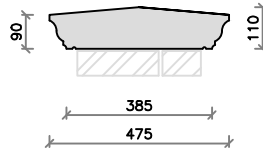

CS36 (32kg)

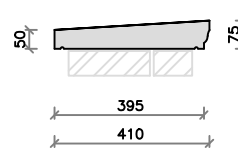

CS40 (35kg)

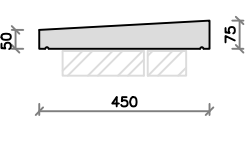

Max length of units are 600mm.

Water drips to underside

External / Internal units and Stop End units are available.

CS41 (47kg)

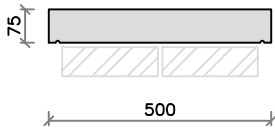

CS42 (55kg)

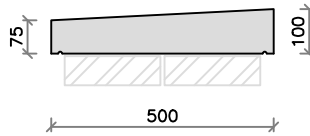

CS43 (55kg)

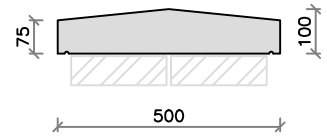

CS44 (65kg)

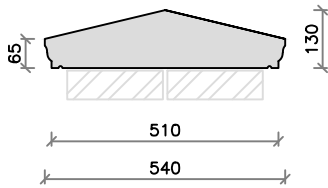

CS44B (43kg)

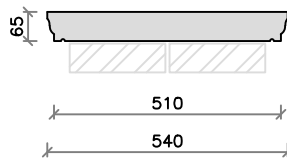

CS44C (65kg)

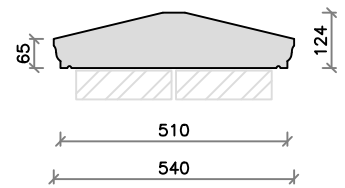

CS45 (58kg)

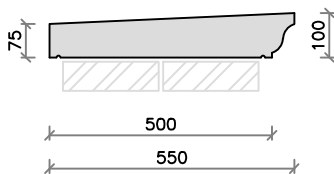

CS47 (69kg)

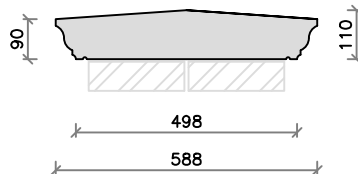

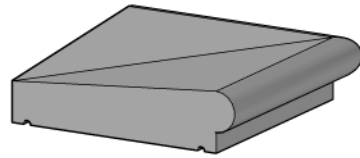

SWP1-90X

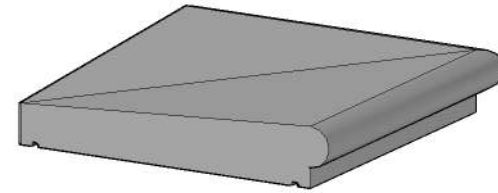

SWP2-90X

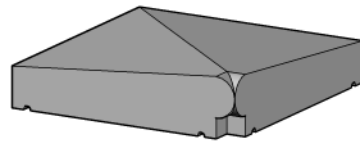

SWP1-90H

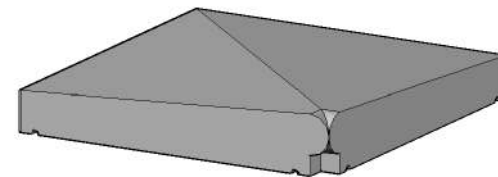

SWP2-90H

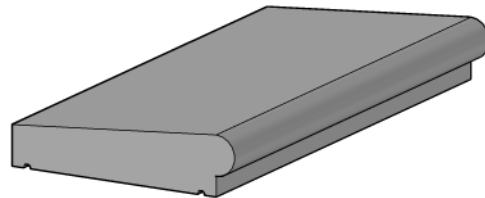

SWP1

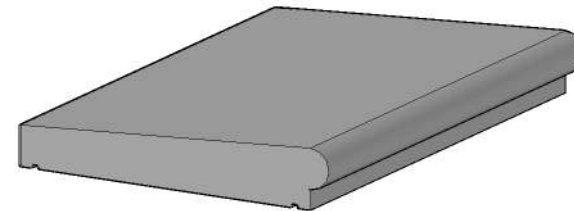

SWP2

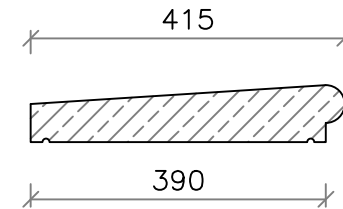
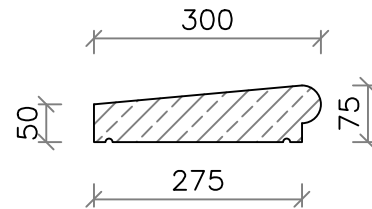

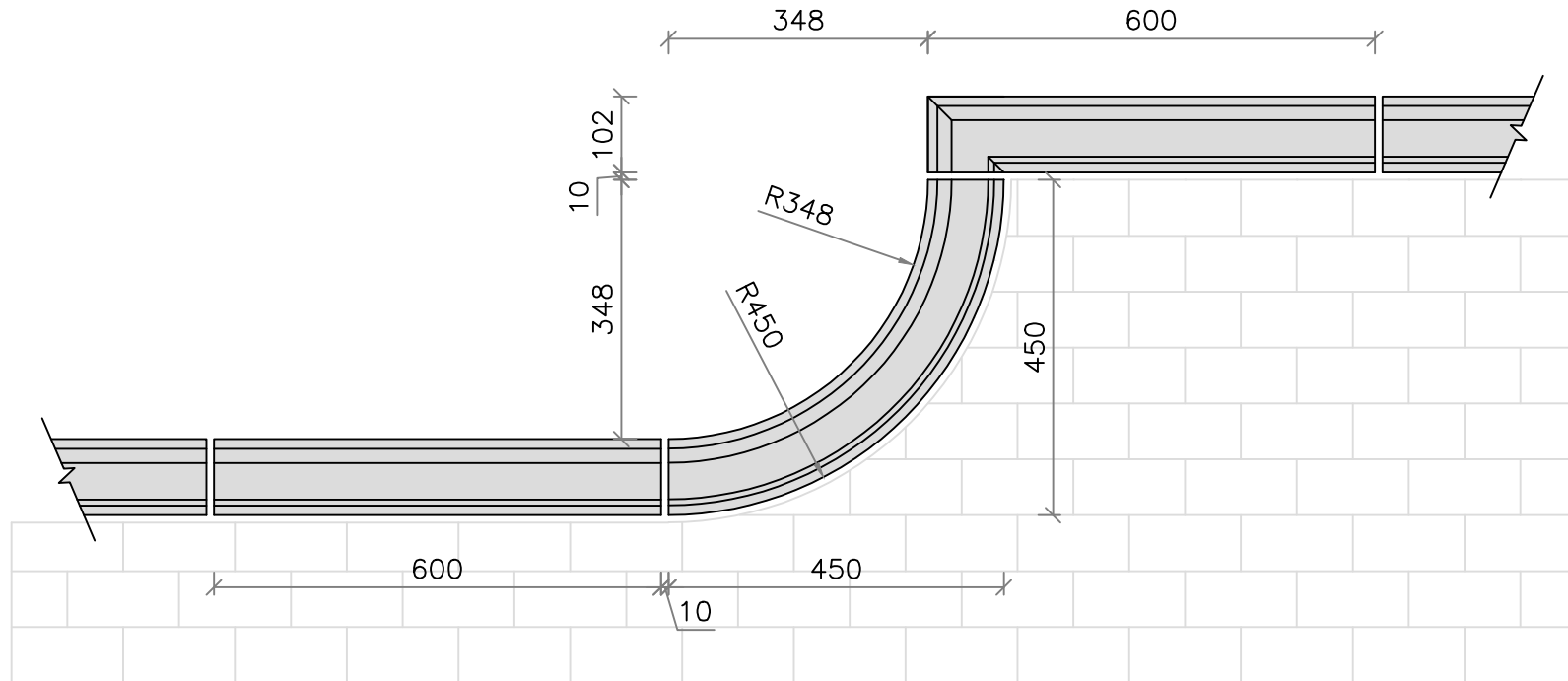

CS18 (41kg)

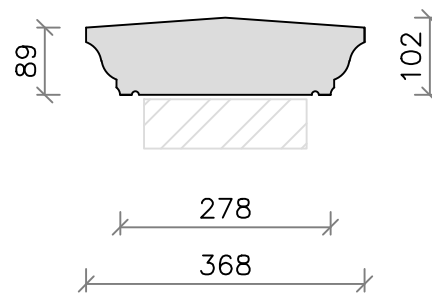

Internal Return

Terminal End Right Hand

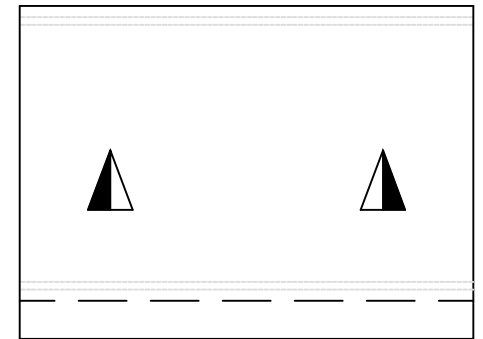
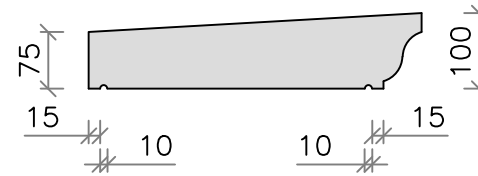
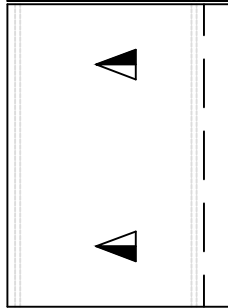
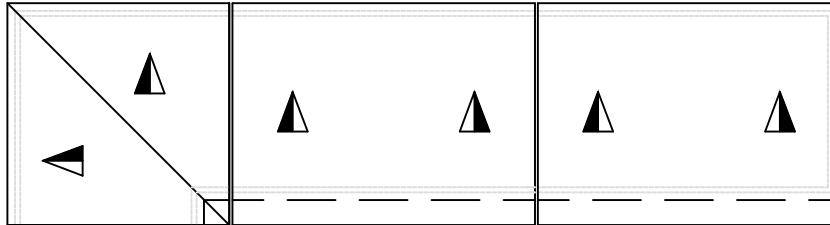

Straights

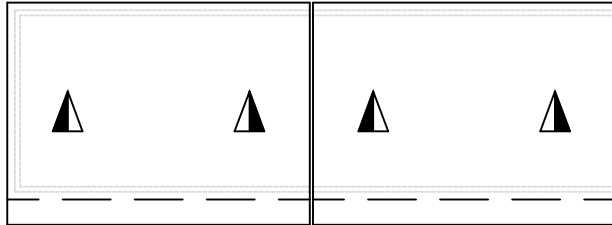

Terminal End Left Hand

External Return

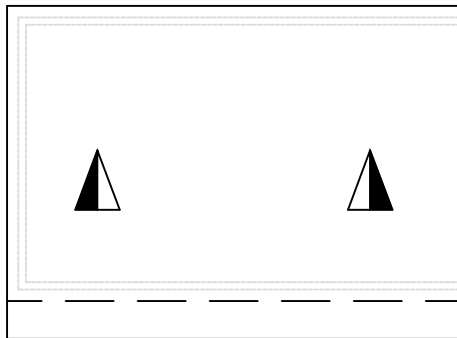

Terminal End Left Hand

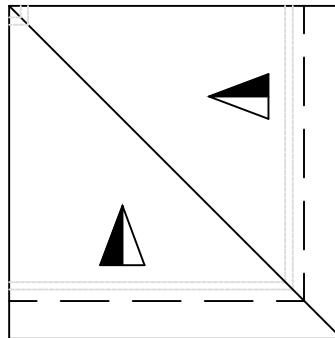

External Return

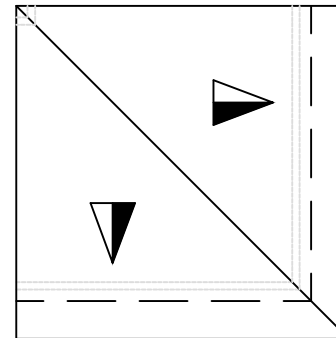

Internal Return

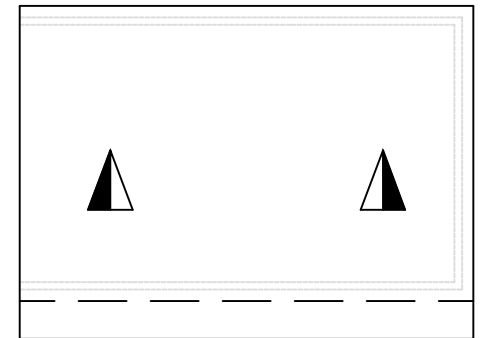

Terminal End Right Hand