

Max length of C1 units are 600mm and C2 to C5 units are 1200mm. Longer units will be manufactured in manageable pieces to suit.

Stool sizes can be adjusted if needed.

C1 Style (16kg/m)

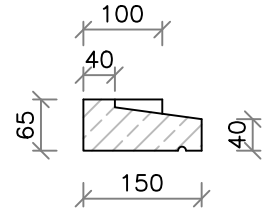
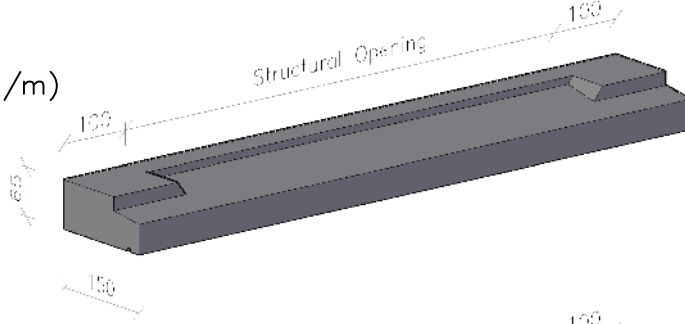

C2 Style (38kg/m)

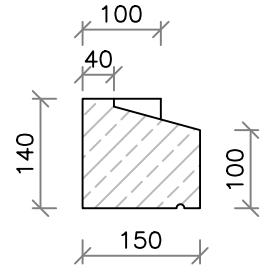
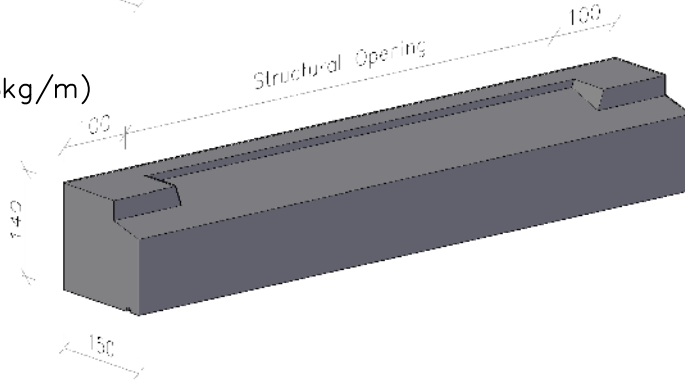

C3 Style (51kg/m)

(Ideal for Sash Windows)

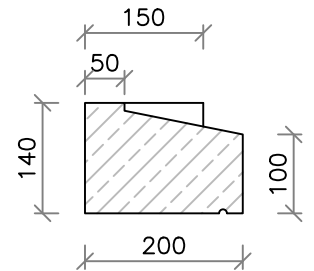
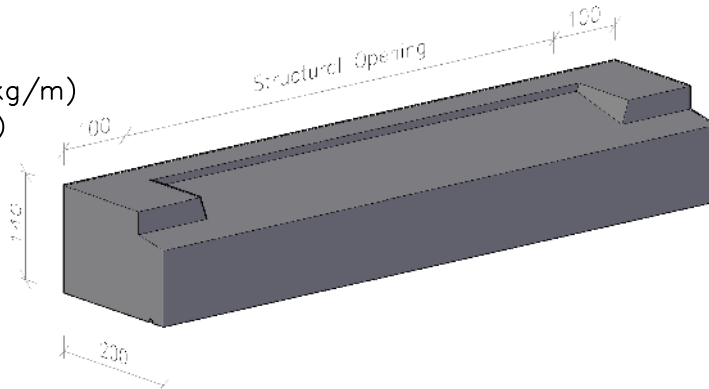

C4 Style (46kg/m)

(Georgian Style)

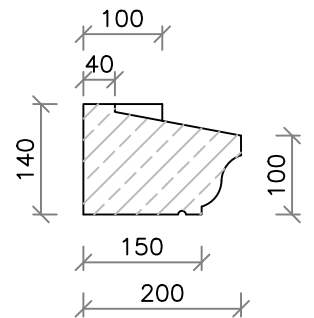
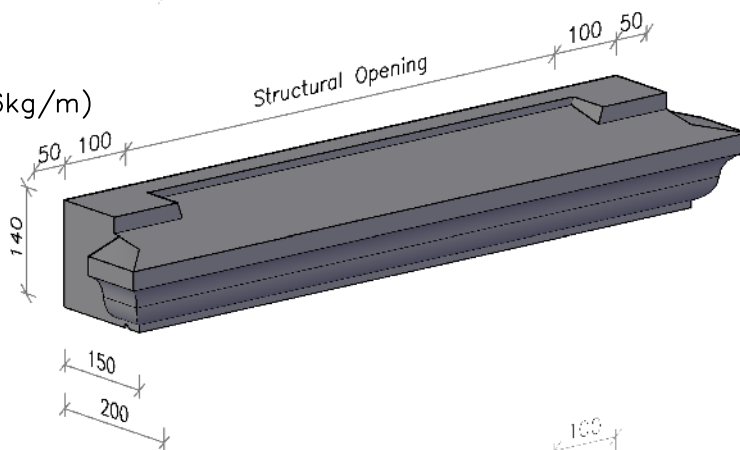

C5 Style (38kg/m)

