

Max length of units are 600mm.

Water drips to underside.

External / Internal units and Stop End units are available.

CS01 (10kg)

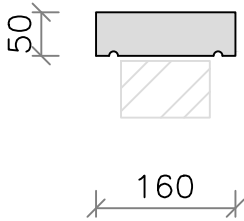

CS02 (13kg)

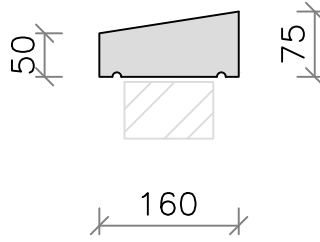

CS03 (16kg)

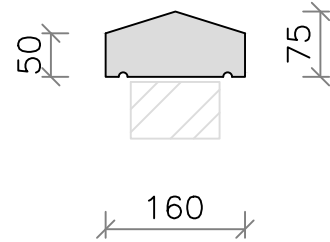

CS04 (13kg)

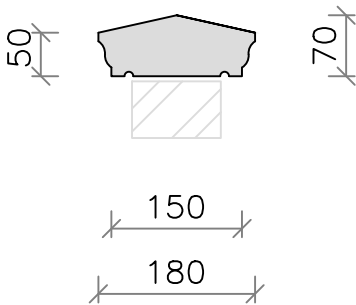

CS04A (15kg)

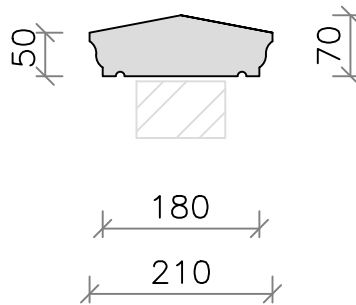

CS04B (10kg)

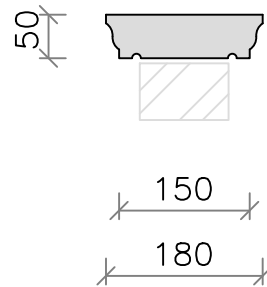

CS04C (12kg)

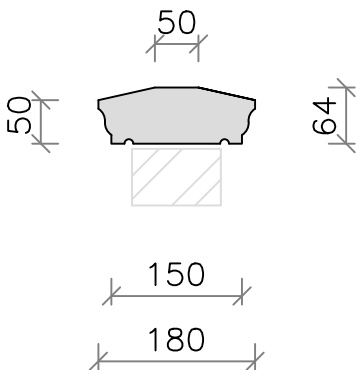

CS05 (12kg)

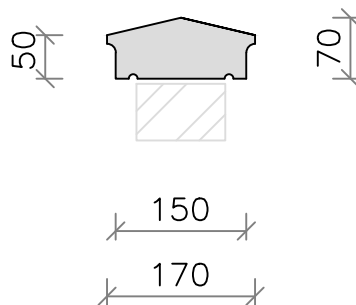

CS08 (19kg)

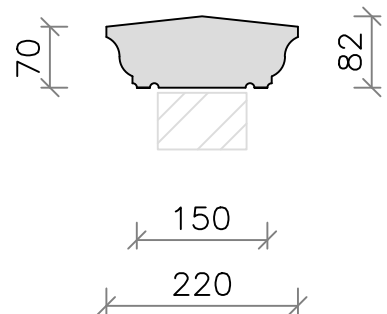

Max length of units are 600mm.

Water drips to underside.

External / Internal units and Stop End units are available.

CS11 (17kg)

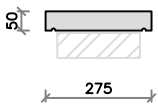

CS11A (19kg)

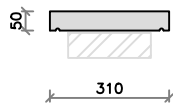

CS12 (22kg)

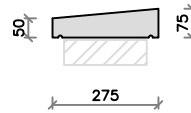

CS12A (24kg)

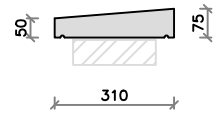

CS13 (22kg)

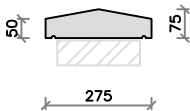

CS13A (24kg)

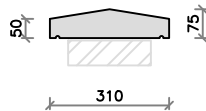

CS14 (31kg)

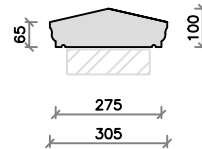

CS14A (34kg)

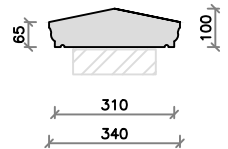

CS14B (24kg)

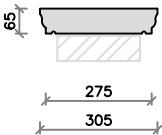

CS14C (30kg)

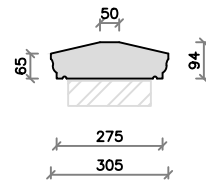

CS15 (29kg)

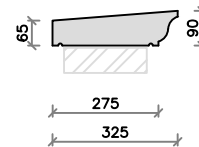

CS17 (37kg)

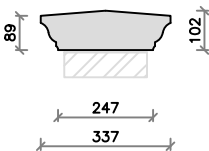

CS18 (41kg)

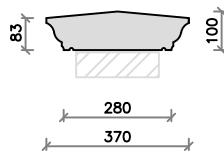

CS19 (25kg)

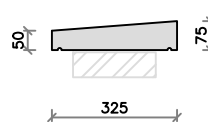

CS51 (30kg)

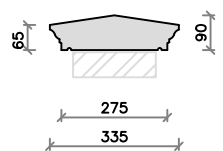

Max length of units are 600mm.

Water drips to underside

External / Internal units and Stop End units are available.

CS20 (24kg)

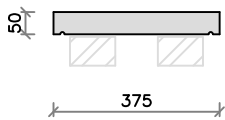

CS21 (25kg)

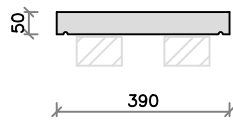

CS22 (31kg)

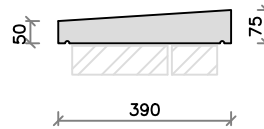

CS23 (30kg)

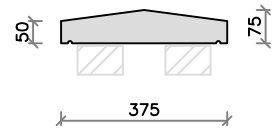

CS24 (30kg)

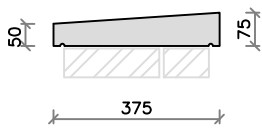

CS31 (37kg)

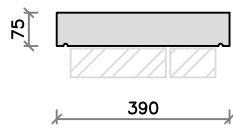

CS32 (32kg)

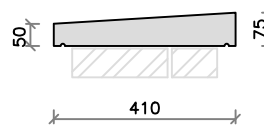

CS33 (31kg)

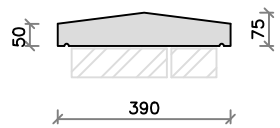

CS34 (45kg)

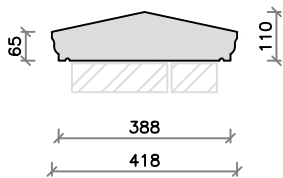

CS34B (33kg)

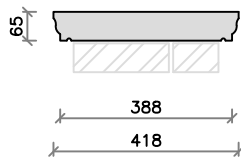

CS34C (45kg)

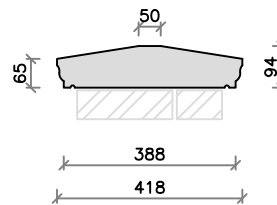

CS35 (46kg)

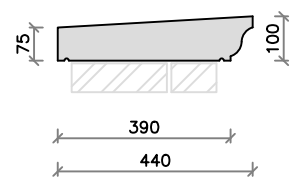

CS28 (47kg)

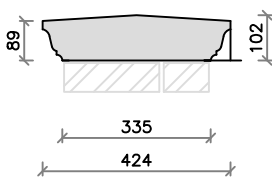

CS37 (56kg)

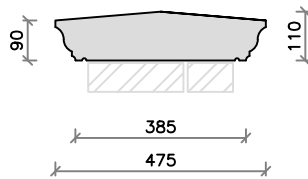

CS36 (32kg)

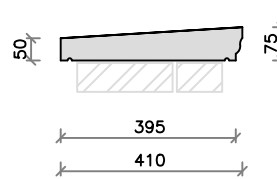

Max length of units are 600mm.

Water drips to underside

External / Internal units and Stop End units are available.

CS41 (47kg)

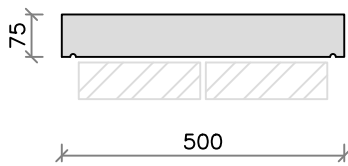

CS42 (55kg)

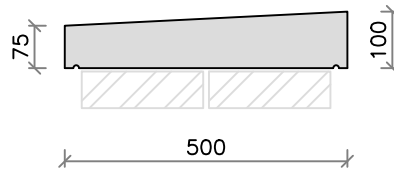

CS43 (55kg)

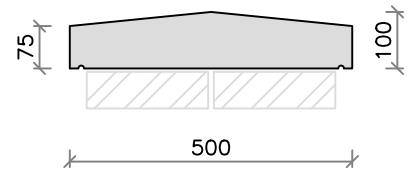

CS44 (65kg)

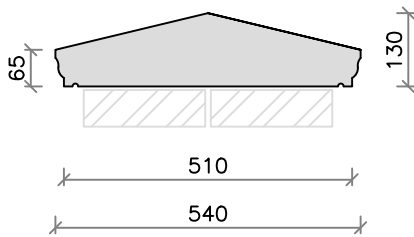

CS44B (43kg)

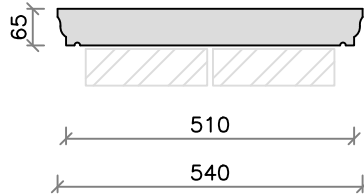

CS44C (65kg)

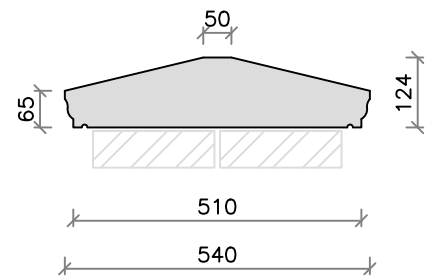

CS45 (58kg)

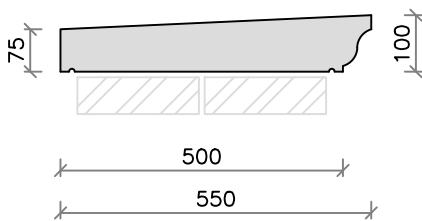

CS47 (69kg)

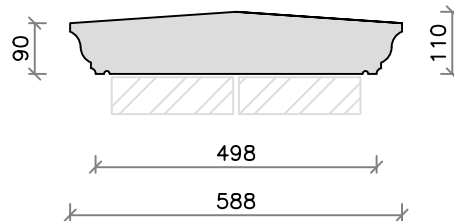

Max length of units are 600mm.

Water drips to underside

External / Internal units and Stop End units are available.

CS48 (52kg)

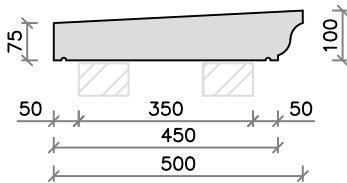

CS49 (42kg)

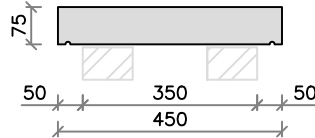

CS50 (50kg)

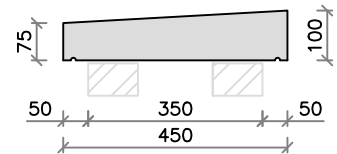

CS52 (55kg)

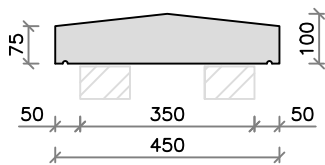

CS54 (55kg)

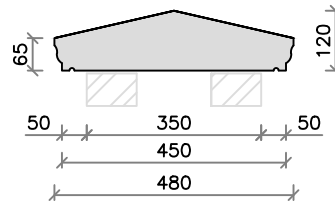

CS54B (38kg)

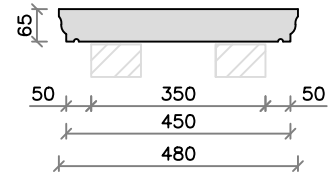

CS54C (55kg)

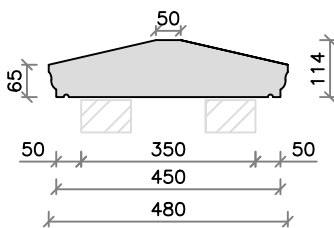

CS56 (63kg)

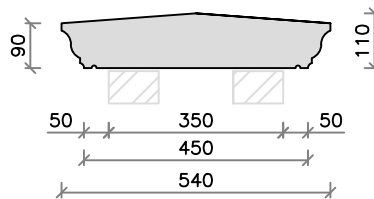

CS57 (66kg)

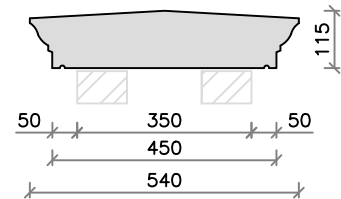

CS58 (36kg)

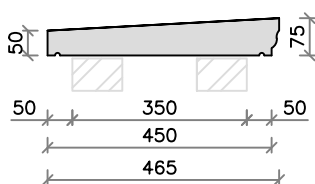

CS40 (35kg)

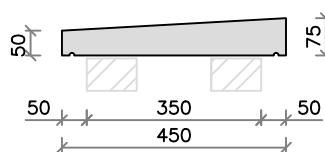

Internal Return Terminal End Right Hand

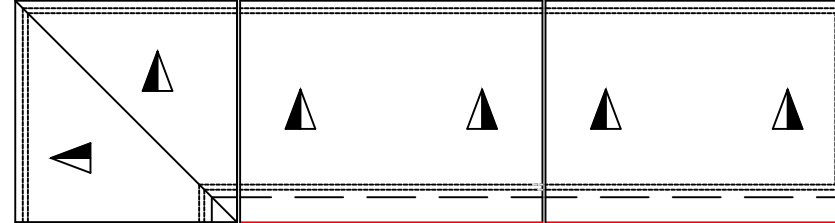

ARROWS POINT IN THE DIRECTION OF THE SLOPE, FROM HIGH TO LOW, OR ALTERNATIVELY THE DIRECTION WHICH WATER WILL FLOW.

THIS IS THE ROOF SIDE

OUTSIDE OF BUILDING

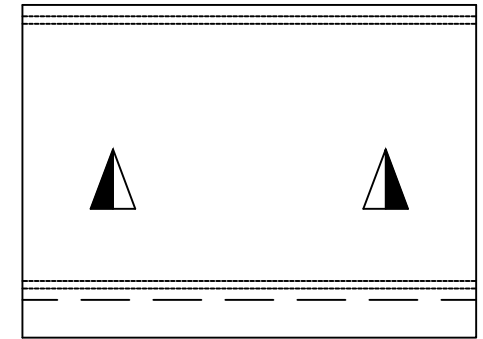
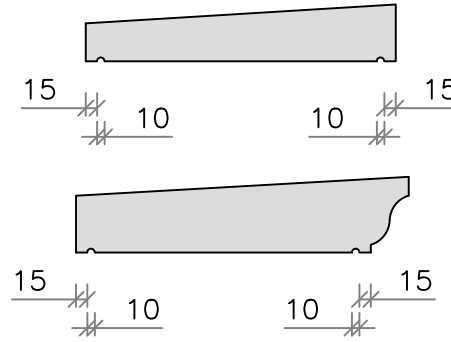
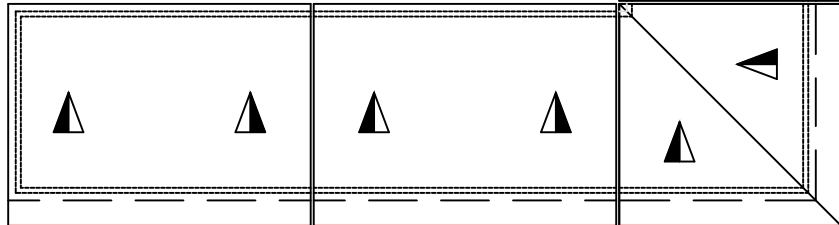

Straights

Terminal End Left Hand

External Return

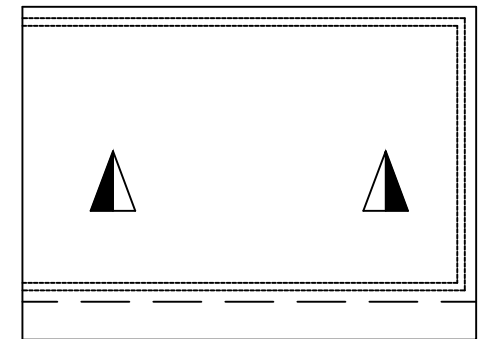
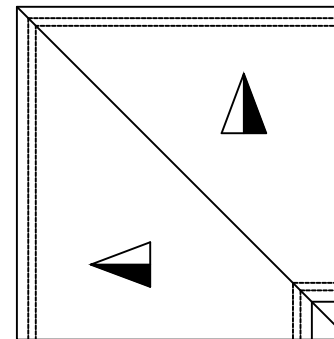
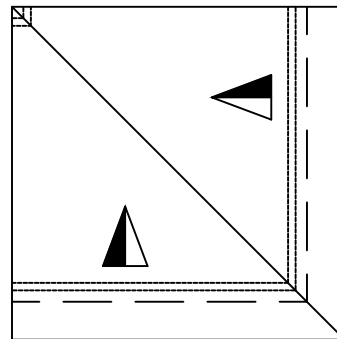
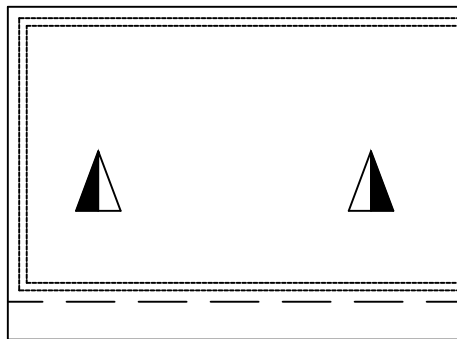

Terminal End Left Hand

External Return

Internal Return

Terminal End Right Hand

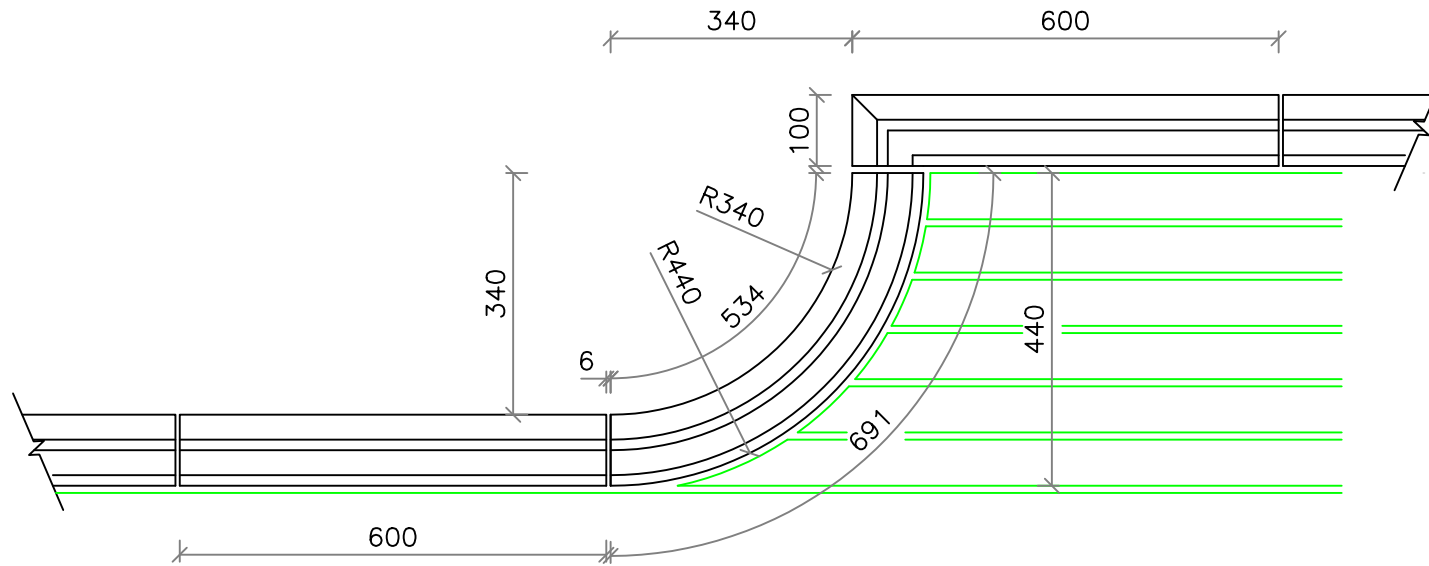

CS14 Drop Down & Vertical Curved Coping

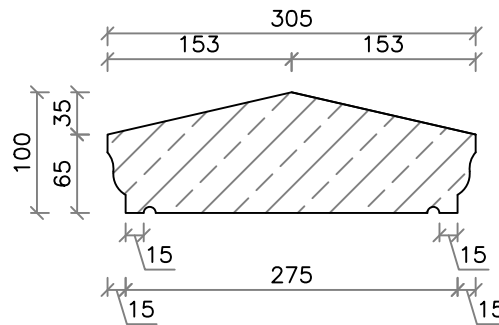

Typical Section

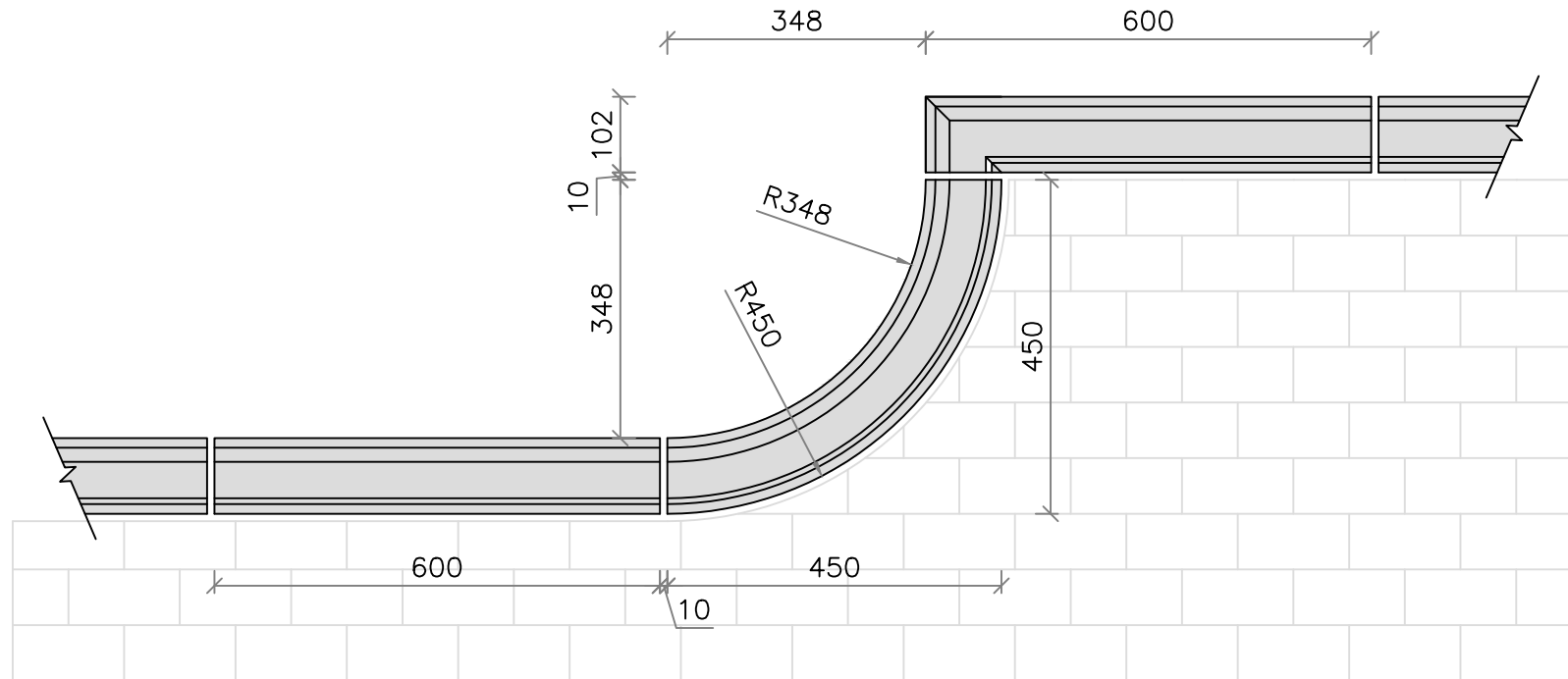

CS18 (41kg)

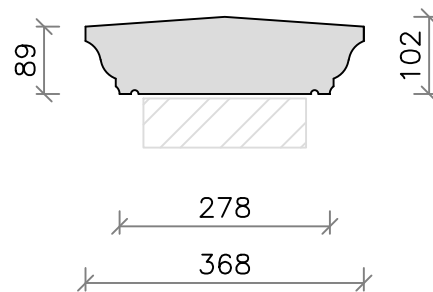

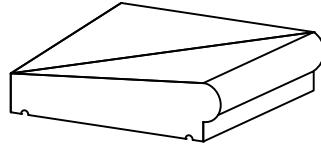

SWP1-90X

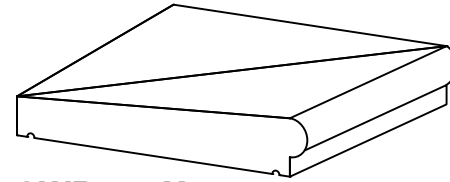

SWP2-90X

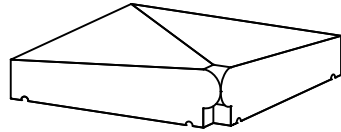

SWP1-90H

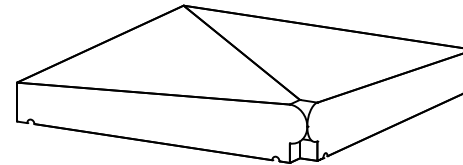

SWP2-90H

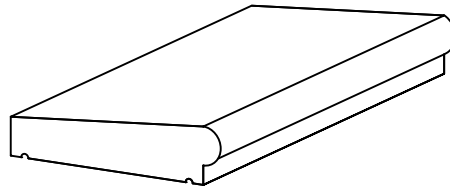

SWP1

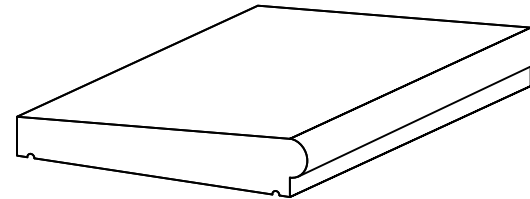

SWP2

