

Max length of units are 600mm.

Water drips to underside.

External / Internal units and Terminal End units are available.

CS01 (10kg)

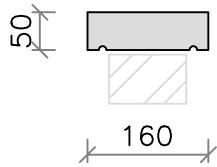

CS02 (13kg)

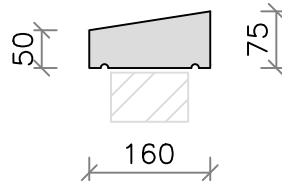

CS03 (16kg)

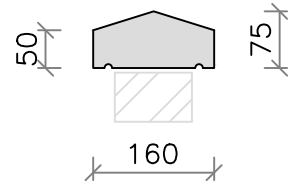

CS04 (13kg)

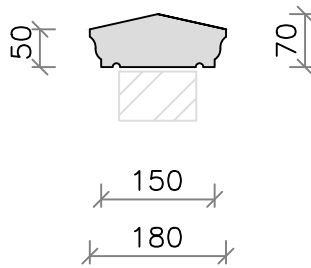

CS04A (15kg)

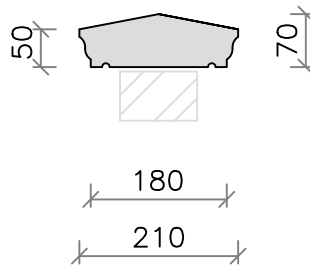

CS04B (10kg)

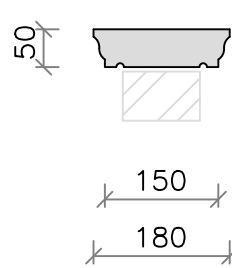

CS04C (12kg)

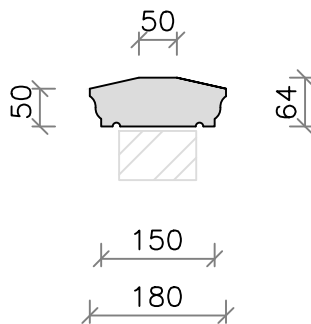

CS05 (12kg)

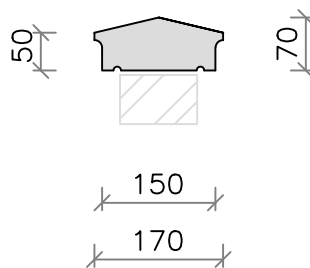

CS08 (19kg)

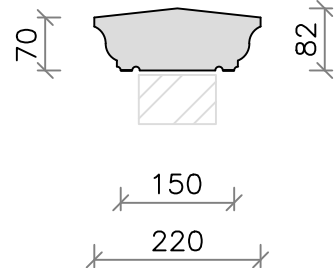

CS60 (9kg)

