

Max length of units are 600mm.

Water drips to underside.

External / Internal units and Terminal End units are available.

**CS01** (10kg)

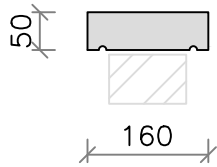

**CS02** (13kg)

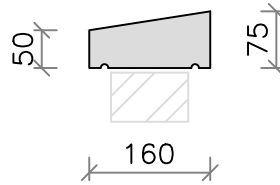

**CS03** (16kg)

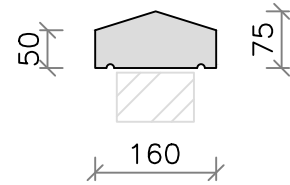

**CS04** (13kg)

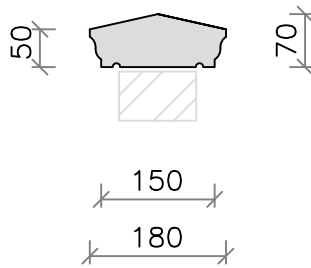

**CS04A** (15kg)

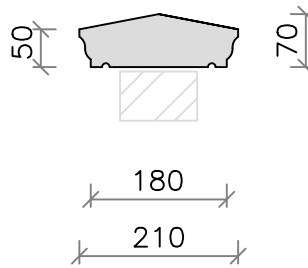

**CS04B** (10kg)

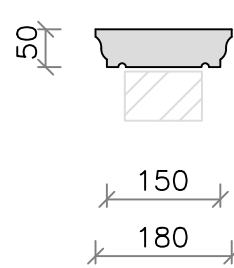

**CS04C** (12kg)

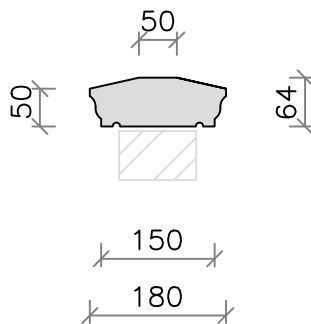

**CS05** (12kg)

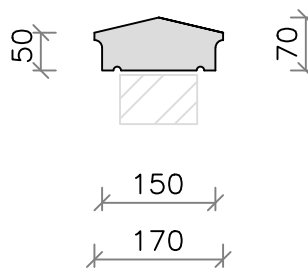

**CS08** (19kg)

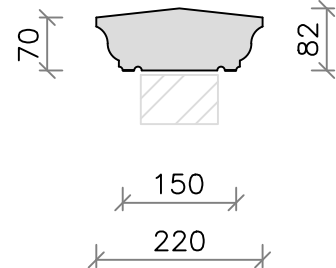

**CS60** (9kg)

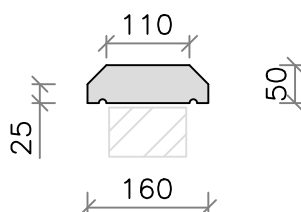

Max length of units are 600mm.

Water drips to underside.

External / Internal units and Terminal End units are available.

**CS11** (17kg)

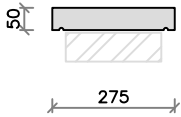

**CS11A** (19kg)

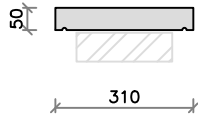

**CS12** (22kg)

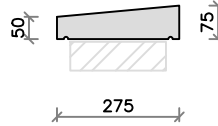

**CS12A** (24kg)

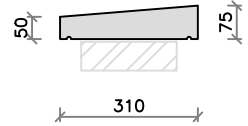

**CS13** (22kg)

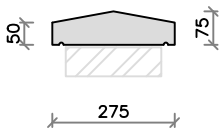

**CS13A** (24kg)

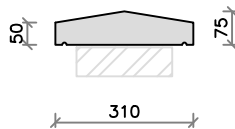

**CS14** (31kg)

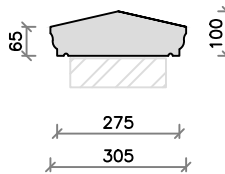

**CS14A** (34kg)

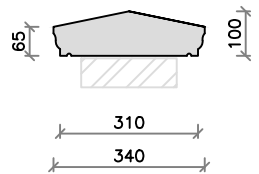

**CS14B** (24kg)

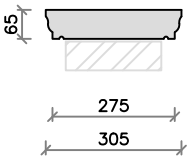

**CS14C** (30kg)

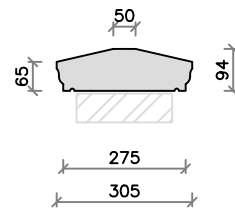

**CS15** (29kg)

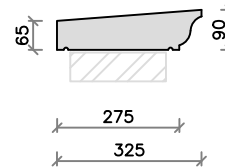

**CS17** (37kg)

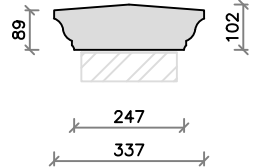

**CS18** (41kg)

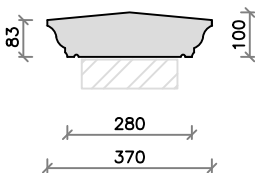

**CS19** (25kg)

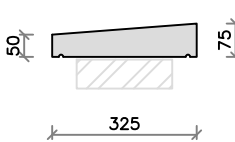

**CS51** (30kg)

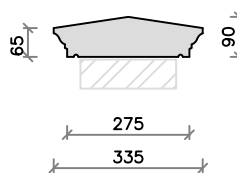

**CS61** (25kg)

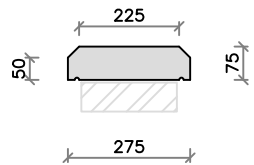

**CS62** (43kg)

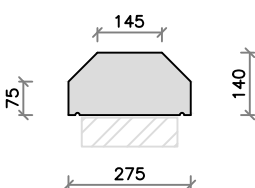

Max length of units are 600mm.

Water drips to underside

External / Internal units and Terminal End units are available.

**CS20** (24kg)

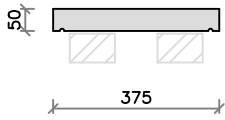

**CS21** (25kg)

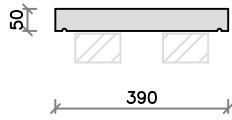

**CS22** (31kg)

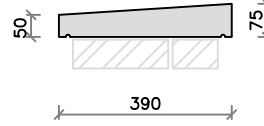

**CS23** (30kg)

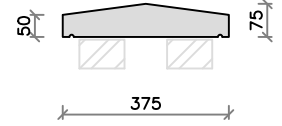

**CS24** (30kg)

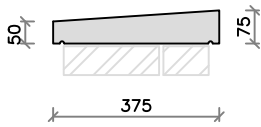

**CS31** (37kg)

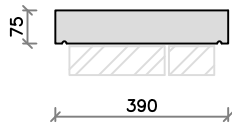

**CS32** (32kg)

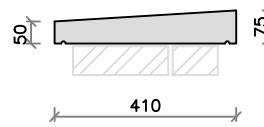

**CS33** (31kg)

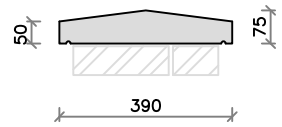

**CS34** (45kg)

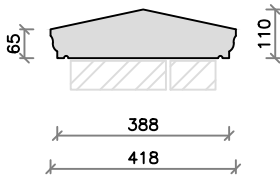

**CS34B** (33kg)

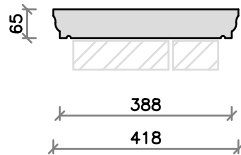

**CS34C** (45kg)

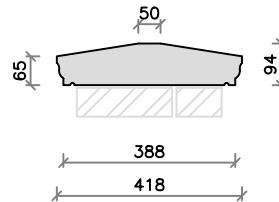

**CS35** (46kg)

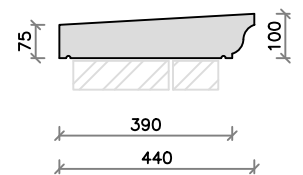

**CS28** (47kg)

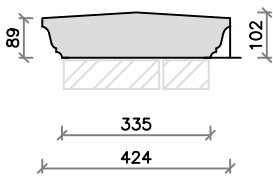

**CS37** (56kg)

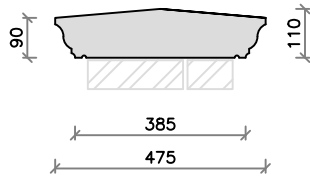

**CS36** (32kg)

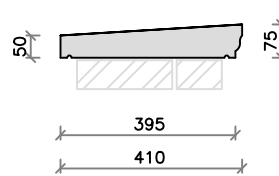

**CS63** (36kg)

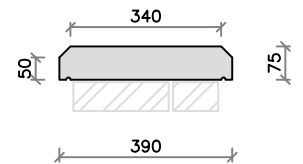

**CS64** (63kg)

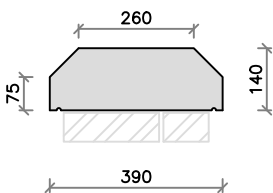

Max length of units are 600mm.

Water drips to underside

External / Internal units and Terminal End units are available.

**CS48** (52kg)

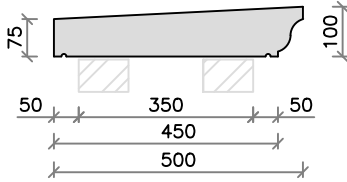

**CS49** (42kg)

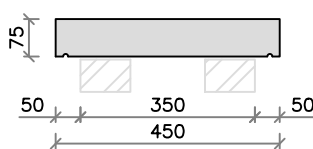

**CS50** (50kg)

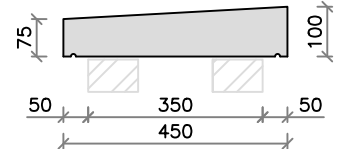

**CS52** (55kg)

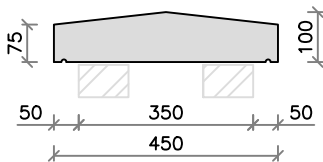

**CS54** (55kg)

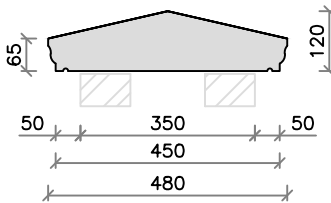

**CS54B** (38kg)

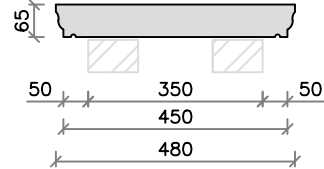

**CS54C** (55kg)

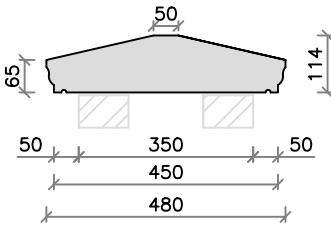

**CS56** (63kg)

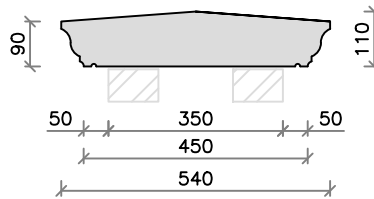

**CS57** (66kg)

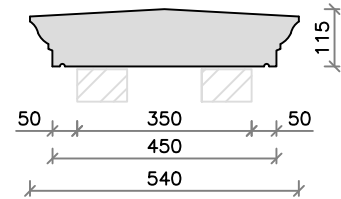

**CS58** (36kg)

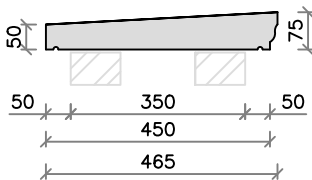

**CS40** (35kg)

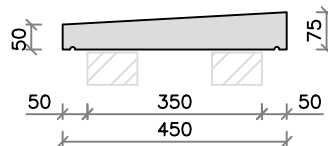

**CS65** (42kg)

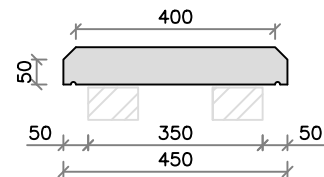

**CS66** (74kg)

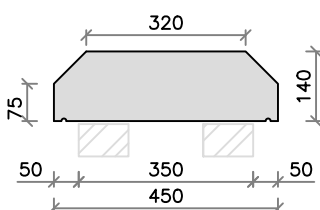

Max length of units are 600mm.

Water drips to underside

External / Internal units and Terminal End units are available.

**CS41** (47kg)

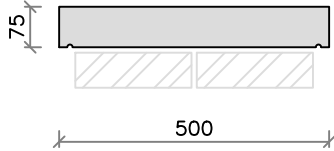

**CS42** (55kg)

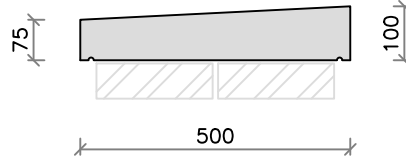

**CS43** (55kg)

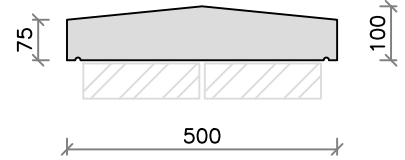

**CS44** (65kg)

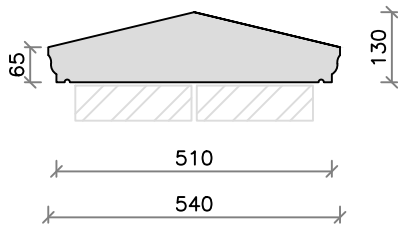

**CS44B** (43kg)

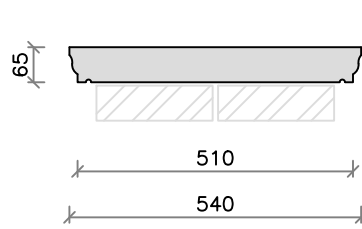

**CS44C** (65kg)

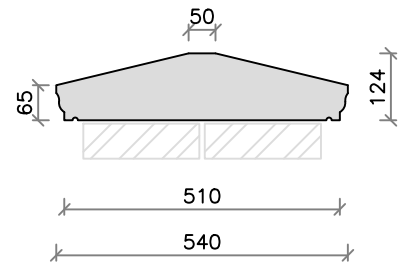

**CS45** (58kg)

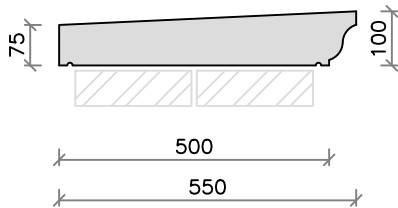

**CS47** (69kg)

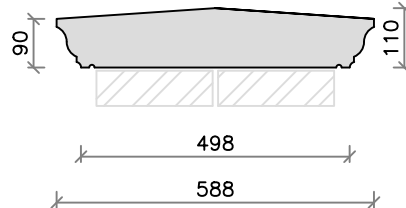

**CS67** (46kg)

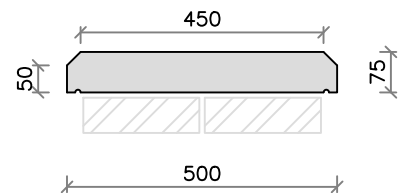

**CS68** (83kg)

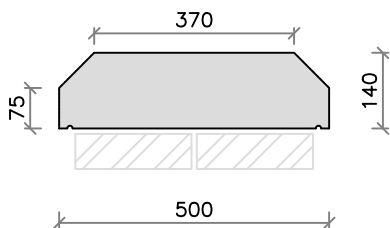

**CS46** (42kg)

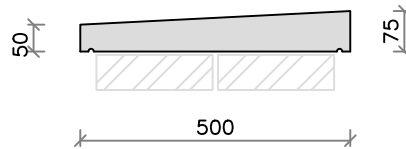

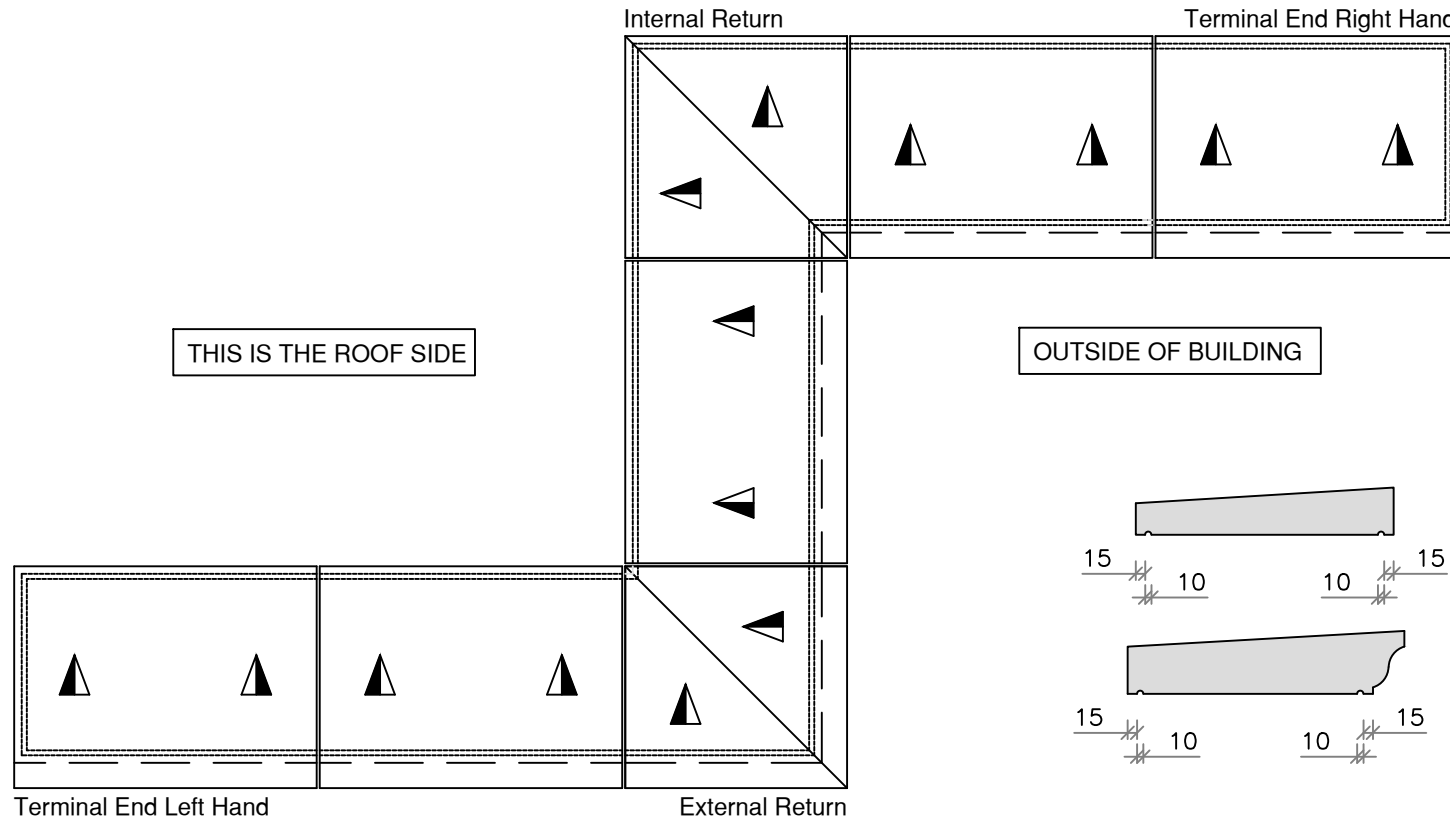

ARROWS POINT IN THE DIRECTION OF THE SLOPE, FROM HIGH TO LOW, OR ALTERNATIVELY THE DIRECTION WHICH WATER WILL FLOW.

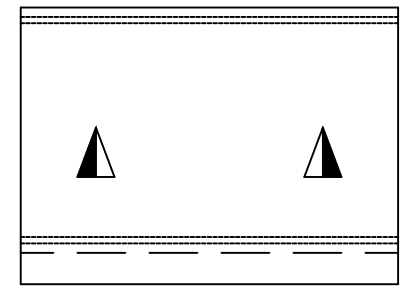
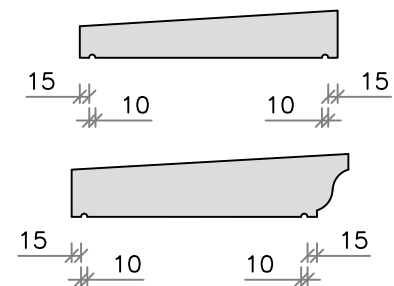

Straights

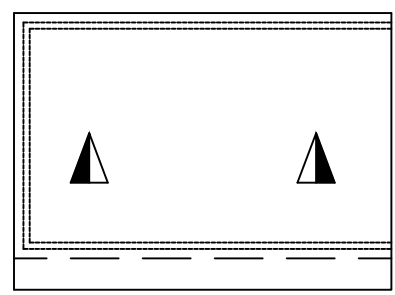

Terminal End Left Hand

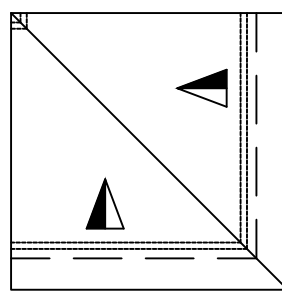

External Return

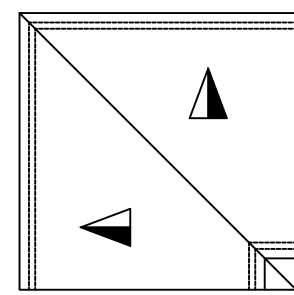

Internal Return

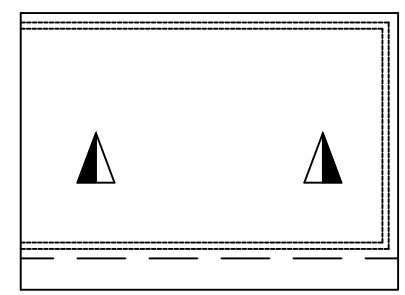

Terminal End Right Hand

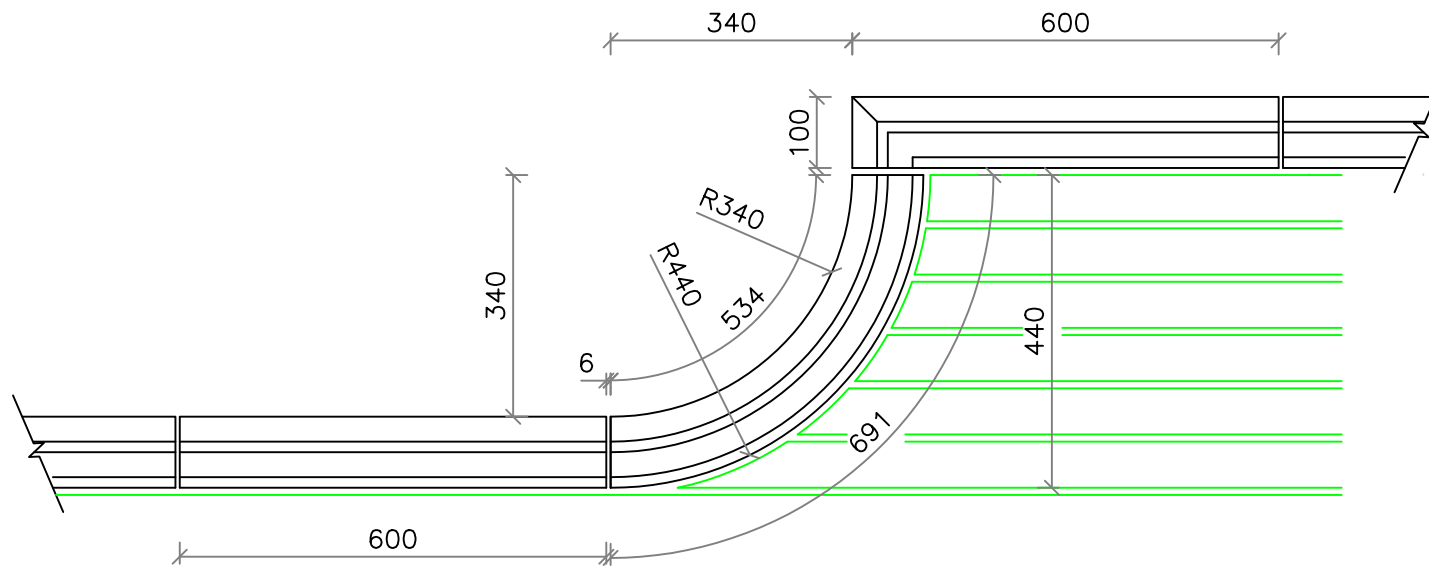

CS14 Drop Down & Vertical Curved Coping

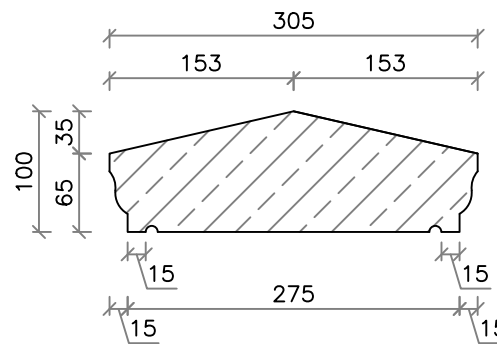

Typical Section

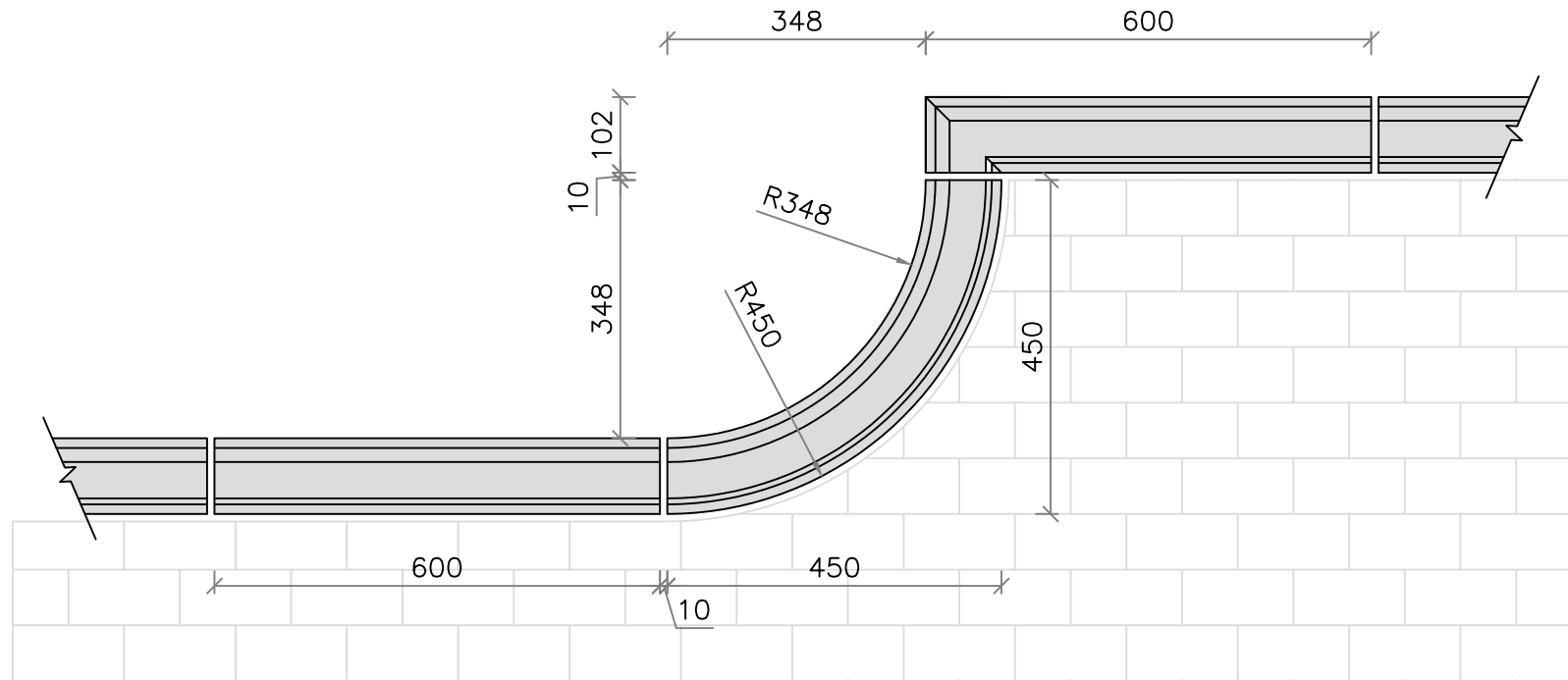

**CS18** (41kg)

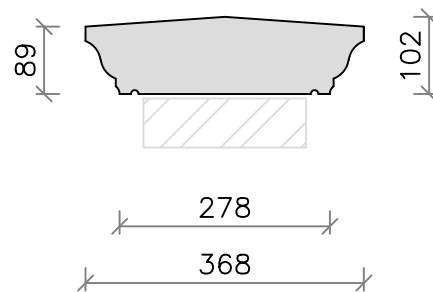

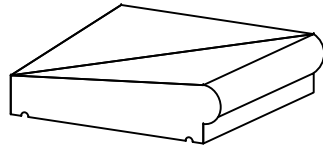

**SWP1-90X**

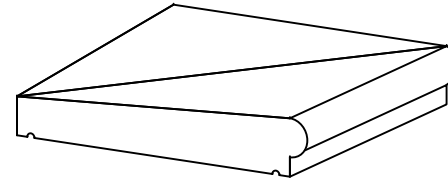

**SWP2-90X**

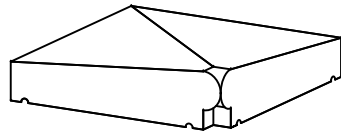

**SWP1-90H**

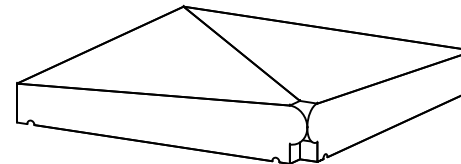

**SWP2-90H**

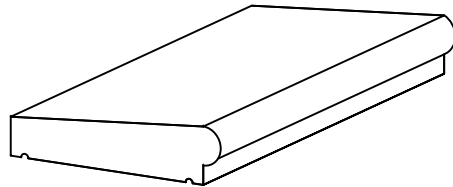

**SWP1**

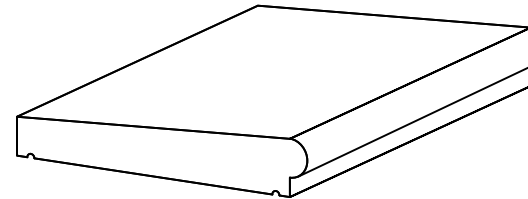

**SWP2**

